



User Manual

ARK-2250

Fanless Embedded Box Computer

ADVANTECH

Enabling an Intelligent Planet

Attention!

Please note:

This package contains a hard-copy user manual in Chinese for China CCC certification purposes, and there is an English user manual included as a PDF file on the website. Please disregard the Chinese hard copy user manual if the product is not to be sold and/or installed in China.

Notez s'il vous plaît:

Ce package contient un manuel de l'utilisateur sur papier en chinois à des fins de certification Chine CCC, et il existe un manuel de l'utilisateur en anglais non inclus sous forme de fichier PDF sur le site Web. Veuillez ne pas tenir compte du manuel de l'utilisateur sur papier chinois si le produit ne doit pas être vendu et / ou installé en Chine.

Copyright

The documentation and the software included with this product are copyrighted 2022 by Advantech Co., Ltd. All rights are reserved. Advantech Co., Ltd. reserves the right to make improvements in the products described in this manual at any time without notice.

No part of this manual may be reproduced, copied, translated or transmitted in any form or by any means without the prior written permission of Advantech Co., Ltd. Information provided in this manual is intended to be accurate and reliable. However, Advantech Co., Ltd. assumes no responsibility for its use, nor for any infringements of the rights of third parties, which may result from its use.

Acknowledgments

Award is a trademark of Award Software International, Inc.

VIA is a trademark of VIA Technologies, Inc.

IBM, PC/AT, PS/2 and VGA are trademarks of International Business Machines Corporation.

Intel® and Pentium® are trademarks of Intel Corporation.

Microsoft Windows® is a registered trademark of Microsoft Corp.

RTL is a trademark of Realtek Semi-Conductor Co., Ltd.

ESS is a trademark of ESS Technology, Inc.

UMC is a trademark of United Microelectronics Corporation.

SMI is a trademark of Silicon Motion, Inc.

Creative is a trademark of Creative Technology LTD.

CHRONTEL is a trademark of Chrontel Inc.

All other product names or trademarks are properties of their respective owners.

For more information about this and other Advantech products, please visit our website at:

<http://www.advantech.com/>

<http://www.advantech.com/ePlatform/>

For technical support and service, please visit our support website at:

<http://support.advantech.com.tw/support/>

Product Warranty (2 years)

Advantech warrants to you, the original purchaser, that each of its products will be free from defects in materials and workmanship for two years from the date of purchase.

This warranty does not apply to any products which have been repaired or altered by persons other than repair personnel authorized by Advantech, or which have been subject to misuse, abuse, accident or improper installation. Advantech assumes no liability under the terms of this warranty as a consequence of such events.

Because of Advantech's high quality-control standards and rigorous testing, most of our customers never need to use our repair service. If an Advantech product is defective, it will be repaired or replaced at no charge during the warranty period. For out-of-warranty repairs, you will be billed according to the cost of replacement materials, service time and freight. Please consult your dealer for more details.

If you think you have a defective product, follow these steps:

1. Collect all the information about the problem encountered. (For example, CPU speed, Advantech products used, other hardware and software used, etc.) Note anything abnormal and list any onscreen messages you get when the problem occurs.
2. Call your dealer and describe the problem. Please have your manual, product, and any helpful information readily available.
3. If your product is diagnosed as defective, obtain a return merchandise authorization (RMA) number from your dealer. This allows us to process your return more quickly.
4. Carefully pack the defective product, a fully-completed Repair and Replacement Order Card and a photocopy proof of purchase date (such as your sales receipt) in a shippable container. A product returned without proof of the purchase date is not eligible for warranty service.
5. Write the RMA number visibly on the outside of the package and ship it prepaid to your dealer.

Declaration of Conformity

FCC Class B

Note: This equipment has been tested and found to comply with the limits for a Class B digital device, pursuant to part 15 of the FCC Rules. These limits are designed to provide reasonable protection against harmful interference in a residential installation. This equipment generates, uses and can radiate radio frequency energy and, if not installed and used in accordance with the instructions, may cause harmful interference to radio communications. However, there is no guarantee that interference will not occur in a particular installation. If this equipment does cause harmful interference to radio or television reception, which can be determined by turning the equipment off and on, the user is encouraged to try to correct the interference by one or more of the following measures:

- Reorient or relocate the receiving antenna
- Increase the separation between the equipment and receiver
- Connect the equipment into an outlet on a circuit different from that to which the receiver is connected
- Consult the dealer or an experienced radio/TV technician for help

Technical Support and Assistance

1. Visit the Advantech website at www.advantech.com/support where you can find the latest information about the product.
2. Contact your distributor, sales representative, or Advantech's customer service center for technical support if you need additional assistance. Please have the following information ready before you call:
 - Product name and serial number
 - Description of your peripheral attachments
 - Description of your software (operating system, version, application software, etc.)
 - A complete description of the problem
 - The exact wording of any error messages

Warnings, Cautions, and Notes

Warning! *Warnings indicate conditions, which if not observed, can cause personal injury!*



Caution! *Cautions are included to help you avoid damaging hardware or losing data.*



There is a danger of a new battery exploding if it is incorrectly installed. Do not attempt to recharge, force open, or heat the battery. Replace the battery only with the same or equivalent type recommended by the manufacturer. Discard used batteries according to the manufacturer's instructions.

Note! *Notes provide optional additional information.*



Warning! *Les avertissements indiquent des conditions qui, si elles ne sont pas respectées, peuvent provoquer des blessures!*



Caution! *Des précautions sont incluses pour vous aider à éviter d'endommager le matériel ou de perdre des données.*



Il y a un risque d'explosion d'une nouvelle batterie si elle n'est pas installée correctement. N'essayez pas de recharger, d'ouvrir de force ou de chauffer la batterie. Remplacez la batterie uniquement par un type identique ou équivalent recommandé par le fabricant. Jetez les piles usagées conformément aux instructions du fabricant.

Note! *Les notes fournissent des informations supplémentaires facultatives.*



Packing List

Before installation, please ensure the following items have been shipped:

- 1 x ARK-2250 unit
- 1 x China RoHS
- 1 x Simplified Chinese manual

Ordering Information

Model Number	Description
ARK-2250L-U6A4	ARK-2250L Intel® Core™ i7-6600U 2.6GHz system
ARK-2250L-U3A4	ARK-2250L Intel® Core™ i3-6100U 2.3GHz system
ARK-2250L-U8A4	ARK-2250L Intel® Core™ i7-7600U
ARK-2250L-U4A4	ARK-2250L Intel® Core™ -3-7100U

Optional Accessories

For ARK-2250

Part Number	Description
96PSA-A60W12W7-3	AC-to-DC Adapter, DC12V/5A 60W with lockable DC jack
MOS-1120Y-0201E	Isolated RS-232, 2-Ch, DB9
MOS-1120Y-1401E	Non-Isolated RS-232, DB37, 4-Ch
MOS-1121Y-0201E	Isolated RS-422/485, 2-Ch, DB9
MOS-1121Y-1401E	Non-Isolated RS-422/485, DB37, 4-Ch
MOS-2120-Z1101E	Giga LAN Ethernet module, 1-Ch
MOS-2220-X1101E	Parallel LPT module, 1-Ch, USB I/F
MOS-1130Y-0201E	Isolated CANBus, 2-Ch, DB9, PCIe I/F
MOS-2230-Z1201E	CANBus module, 2-Ch, USB I/F
MOS-1110Y-0101E	Isolated 16 DI/8 DO, 1-Ch, DB37, PCIe I/F
MIOE-PWR2-00A1E	9~36V DC-in power module
96PSA-A65W19P2-1	AC-to-DC Adapter, DC19V/3.42A 65W (for MIOe-PWR2)
AMO-2201E	4 x RS232/422/485+ removable 2.5" drive (2nd layer)
AMO-2203E	2 x isolated CAN-Bus (2nd layer)
AMO-2202E	4 x 10/100/1000Base T(X) PoE

Safety Instructions

1. Please read these safety instructions carefully.
2. Please keep this User Manual for later reference.
3. Please disconnect this equipment from AC outlet before cleaning. Use a damp cloth. Don't use liquid or sprayed detergent for cleaning. Use a moist sheet or cloth for cleaning.
4. For pluggable equipment, the socket-outlet should be near the equipment and should be easily accessible.
5. Protect this equipment from humidity.
6. Lay this equipment on a reliable surface when installing. A drop or fall could cause injury.
7. The openings on the enclosure are for air convection and protecting the equipment from overheating. **DO NOT COVER THE OPENINGS.**
8. Make sure the voltage of the power source when connecting the equipment to the power outlet. The power outlet socket should have ground connection.
9. Place the power cord such a way that people cannot step on it. Do not place anything over the power cord.
10. All cautions and warnings on the equipment should be noted.
11. If the equipment is not used for long time, disconnect the equipment from mains to avoid being damaged by transient over-voltage.
12. Never pour any liquid into ventilation openings; this could cause fire or electrical shock.
13. Never open the equipment. For safety reasons, only qualified service personnel should open the equipment.
14. If one of the following situations arises, get the equipment checked by service personnel:
 - The power cord or plug is damaged
 - Liquid has penetrated into the equipment
 - The equipment has been exposed to moisture
 - The equipment does not work well, or you cannot get it to work according to the user manual
 - The equipment has been dropped and damaged
 - The equipment has obvious signs of breakage
15. Do not leave this equipment in an environment where the storage temperature may go below $-40\text{ }^{\circ}\text{C}$ ($-40\text{ }^{\circ}\text{F}$) or above $85\text{ }^{\circ}\text{C}$ ($185\text{ }^{\circ}\text{F}$). This could damage the equipment. the equipment should be in a controlled environment.
16. Caution: Danger of explosion if battery is incorrectly replaced. Replace only with the same or equivalent type recommended by the manufacturer, discard used batteries according to the manufacturer's instructions.
17. The sound pressure level at the operator's position according to IEC 704-1:1982 is no more than 70 dB (A).
18. **RESTRICTED ACCESS AREA:** The equipment should only be installed in a Restricted Access Area.
19. **DISCLAIMER:** This set of instructions is given according to IEC 704-1. Advantech disclaims all responsibility for the accuracy of any statements contained herein.
20. The product is to be connected only to PoE networks without routing to the outside plant.
21. The product is intended to be supplied by an Listed power supply or dc ES1, rated 12Vdc, 5A/12Vdc, 10A/9-36Vdc, 8-2A to match the unit rating, if need further assistance, please contact Advantech for further information.

Safety Instructions

1. Veuillez lire attentivement ces consignes de sécurité.
2. Veuillez conserver ce manuel d'utilisation pour référence ultérieure.
3. Veuillez déconnecter cet équipement de la prise secteur avant de le nettoyer. Utilisez un chiffon humide. N'utilisez pas de détergent liquide ou pulvérisé pour le nettoyage. Utilisez une feuille d'humidité ou des vêtements pour le nettoyage.
4. Pour les équipements enfichables, la prise de courant doit être proche de l'équipement et doit être facilement accessible.
5. Veuillez garder cet équipement à l'abri de l'humidité.
6. Posez cet équipement sur une surface fiable lors de l'installation. Une chute ou une chute pourrait provoquer des blessures.
7. Les ouvertures sur l'enceinte sont destinées à la convection d'air, protégeant ainsi l'équipement de la surchauffe. **NE COUVREZ PAS LES OUVERTURES.**
8. Assurez-vous de la tension de la source d'alimentation lorsque vous connectez l'équipement à la prise de courant. La prise de courant doit avoir une connexion à la terre.
9. Placez le cordon d'alimentation de manière à ce que personne ne puisse marcher dessus. Ne placez rien sur le cordon d'alimentation.
10. Toutes les précautions et avertissements sur l'équipement doivent être notés.
11. Si l'équipement n'est pas utilisé pendant une longue période, débranchez-le du secteur pour éviter d'être endommagé par une surtension transitoire.
12. Ne versez jamais de liquide dans les ouvertures de ventilation; cela pourrait provoquer un incendie ou un choc électrique.
13. N'ouvrez jamais l'équipement. Pour des raisons de sécurité, seul un technicien qualifié doit ouvrir l'équipement.
14. Si l'une des situations suivantes se présente, faites vérifier l'équipement par le personnel de service:
 - Le cordon d'alimentation ou la fiche est endommagé.
 - Du liquide a pénétré dans l'équipement.
 - L'équipement a été exposé à l'humidité.
 - L'équipement ne fonctionne pas bien, ou vous ne pouvez pas le faire fonctionner selon le manuel de l'utilisateur.
 - L'équipement est tombé et a été endommagé.
 - L'équipement présente des signes évidents de rupture.
15. Ne laissez pas cet équipement dans un environnement où la température de stockage peut être inférieure à -40°C (-40°F) ou supérieure à 85°C (185°F). Cela pourrait endommager l'équipement. l'équipement doit se trouver dans un environnement contrôlé.
16. Attention: risque d'explosion si la batterie n'est pas remplacée correctement. Remplacez uniquement par un type identique ou équivalent recommandé par le fabricant, jetez les piles usagées conformément aux instructions du fabricant.
17. Le niveau de pression acoustique au poste de l'opérateur selon CEI 704-1: 1982 n'est pas supérieur à 70 dB (A).
18. **ZONE D'ACCÈS RESTREINT:** l'équipement ne doit être installé que dans une zone d'accès restreint.
19. **AVIS DE NON-RESPONSABILITÉ:** Cet ensemble d'instructions est donné conformément à la CEI 704-1. Advantech décline toute responsabilité quant à l'exactitude des déclarations contenues dans le présent document.
20. Le produit doit être connecté uniquement aux réseaux PoE sans acheminement vers l'installation extérieure.

21. Le produit est destiné à être alimenté par un bloc d'alimentation homologué ou dc ES1, évalué à 12Vdc, 5A / 12Vdc, 10A / 9-36Vdc, 8-2A pour correspondre à la puissance nominale de l'unité. Si besoin d'assistance supplémentaire, veuillez contacter Advantech pour plus d'informations.

Contents

Chapter 1	General Introduction	1
1.1	Introduction	2
1.2	Product Features.....	3
1.2.1	General	3
1.2.2	Display	3
1.2.3	Ethernet	3
1.3	Chipset.....	4
1.3.1	Functional Specification	4
1.3.2	WISE-PaSS/RMM.....	5
1.4	Mechanical Specifications.....	5
1.4.1	Dimensions	5
	Figure 1.1 ARK-2250 Mechanical Dimension Diagram	5
1.4.2	Weight.....	5
1.5	Power Requirements.....	5
1.5.1	System Power.....	5
1.5.2	RTC Battery	5
1.6	Environment Specification.....	6
1.6.1	Operating Temperature.....	6
1.6.2	Relative Humidity	6
1.6.3	Storage Temperature.....	6
1.6.4	Vibration During Operation	6
1.6.5	Shock During Operation.....	6
1.6.6	Safety.....	6
1.6.7	EMC.....	6
Chapter 2	H/W Installation.....	7
2.1	Introduction	8
2.2	Jumpers	8
2.2.1	Jumper Description	8
2.2.2	Jumper List	8
	Table 2.1: Jumper Settings.....	8
2.2.3	Jumper Location	9
	Figure 2.1 Jumper Layout.....	9
2.2.4	Jumper Settings.....	9
	Table 2.2: J1: AT/ATX Mode	9
	Table 2.3: SW2: Clear CMOS	10
	Table 2.4: J5: COM3/COM4 Termination	10
	Table 2.5: J6: COM1/COM2 Termination	10
2.3	Connectors.....	11
2.3.1	ARK-2250 External I/O	11
	Figure 2.2 ARK-2250 I/O	11
	Figure 2.3 Power On/Off Button	11
	Figure 2.4 LED.....	11
	Figure 2.5 HDMI Connector.....	12
	Figure 2.6 VGA Connector	12
	Figure 2.7 USB 3.0 Connector.....	13
	Figure 2.8 USB 2.0 Connector.....	13
	Figure 2.9 Ethernet Connector (LAN).....	14
	Figure 2.10 Audio Connector	14
	Figure 2.11 GPIO Connector	15
2.4	Installation	16
2.4.1	Memory Installation.....	16
2.4.2	HDD/SSD Installation.....	17

2.4.3	mSATA Installation	19
2.4.4	Power Module (MIOe-PWR2) Installation (Optional)	20
2.4.5	iDoor Module Installation (Option)	23
2.4.6	2nd Layer MIOe Module Installation (Option)	23
2.4.7	Wall Mount Installation (Option)	23

Chapter 3 BIOS Settings 25

3.1	Entering Setup	26
3.2	Main	26
3.3	Advanced	28
3.3.1	ACPI Settings	29
3.3.2	AMT Configuration	30
3.3.3	PCH-FW Configuration	31
3.3.4	Embedded Controller Configuration	32
3.3.5	Trusted Computing	33
3.3.6	S5 RTC Wake Settings	33
3.3.7	Serial Port Console Redirection	34
3.3.8	CPU Configuration	35
3.3.9	Intel TXT Information	37
3.3.10	Platform Misc Configuration	38
3.3.11	SATA Configuration	39
3.3.12	Network Stack Configuration	41
3.3.13	CSM Configuration	42
3.3.14	USB Configuration	43
3.3.15	First Super IO Configuration	44
3.4	Chipset	46
3.4.1	System Agent Configuration	47
3.4.2	PCH-IO Configuration	51
3.5	Security Setup	56
3.6	Boot Settings	57
3.7	Save & Exit	58

Appendix A Watchdog Timer Sample Code 59

A.1	EC Watchdog Timer sample code	60
-----	-------------------------------------	----

Chapter 1

General Introduction

This chapter details background information on the ARK-2250 series.

1.1 Introduction

ARK-2250 is an intelligent, modular, and fanless embedded system. A fully modular design, ARK-2250 supports easy I/O switching with optional iDoor modules, wide range power board, and MIOe board expansions. ARK-2250 is aimed at factory automation, machine automation, kiosks, and self-service applications.

Rugged, Multi-functional Design

ARK-2250 embedded box PC is powered by an 6th Gen Intel® Core™ i3/i7 processor. This compact size system provides a selection of I/O ports: 4 x USB 3.0, 2 x USB 2.0, 2 x GbE, 4 x COM, 2 x mPCIe and 1 x 2.5" HDD. The default power input is 12V DC in, with optional wide range 9~36V power module with wide temperature operation (-20 ~ 60 °C). ARK-2250 adheres to diverse certification including CE/FCC, CB, UL, CCC and BSMI.

Multiple Display Support

ARK-2250 supports up to 3 x display types: VGA, HDMI as the default display, and an expansion display module. It can also provide DP, HDMI, DVI-D as a 3rd optional display port. The graphic engine is DirectX 11.3, OpenGL 4.4, and OpenCL 2.1 Full AVC/VC1/MPEG2 HW Decode.

Built-in Intelligent Management Tools — WISE-PaSS/RMM

Advantech WISE-PaSS/RMM provides a valuable suite of programmable APIs such as multi-level watchdog, hardware monitor, system restore, and other user-friendly interfaces. iManager is an intelligent self-management cross platform tool that monitors system status for problems and takes action if anything is abnormal. It offers a boot up guarantee in critical, low temperature environments so systems can automatically recover when voltages dip. WISE-PaSS/RMM makes the whole system more reliable and more intelligent. ARK-2250L provides easy remote management so users can monitor, configure, and control a large number of terminals to make maintenance and system recovery simpler.

1.2 Product Features

1.2.1 General

- **CPU:**
 - 6th Gen Intel® Core™ i7-6600U processor 2.6GHz
 - 6th Gen Intel® Core™ i3-6100U processor 2.3GHz
 - 7th Gen Intel® Core™ i7-7600U processor 2.8GHz
 - 7th Gen Intel® Core™ i3-7100U processor 2.4GHz
- **BIOS:** AMI UEFI 128Mbit
- **System Memory:** 1x DDR4 2133 MHz up to 16 GB
- **Watchdog Timer:** Single chip Watchdog 255-level interval timer, setup by software
- **I/O Interface:** 4 x RS232/422/485
- **USB:** 2 x USB 2.0, 4 x USB 3.0 compliant ports
- **Audio:** High Definition Audio (HD), Line out, Mic-in
- **Storage:** 1 x mSATA and 1 x high capacity 2.5" SATA HDD (up to 12.5 mm/.49 in) height
- **Expansion Interface:**
 - Supports 2 x MiniPCIe (1 with SIM holder)
 - Supports 1 x iDoor expansion (by 1st layer)
 - Supports 1 x ARK Plus expansion (by 2nd layer)

1.2.2 Display

- **Controller:** Intel® HD Graphics 520
- **Resolution:**
 - VGA: Supports up to 1920 x 1200
 - HDMI: Supports up to 4096 x 2160 @ 24Hz
- **Dual Display:** VGA+HDMI
- **Triple Display:** VGA+HDMI+3rd optional display

1.2.3 Ethernet

- **Chipset:**
 - LAN1 Intel i219
 - LAN2 Intel i210
- **Speed:** 1000 Mbps
- **Interface:** 2 x RJ45
- **Standard:** Compliant with IEEE 802.3, IEEE 802.3u, IEEE 802.3x, IEEE 802.3y, IEEE 802.ab.

1.3 Chipset

1.3.1 Functional Specification

1.3.1.1 Processor

Processor	6th Gen. Intel® Core™ i7-6600U processor 2.6GHz 6th Gen. Intel® Core™ i3-6100U processor 2.3GHz 7th Gen. Intel® Core™ i7-7600U processor 2.8GHz 7th Gen. Intel® Core™ i3-7100U processor 2.4GHz
Memory	Supports DDR4 2133 MHz up to 16GB 1 x 260-pin SODIMM socket type

1.3.1.2 Chipset

Internal Graphics Features	<ul style="list-style-type: none">■ DirectX 11.3, OpenGL 4.4■ Display Ports VGA + HDMI, HDMI 1.4a
Video Accelerator	<ul style="list-style-type: none">■ H/W accelerated video decode■ Video decoder: AVC/VC1/MPEG2 HW Decode■ Supports DVD, Blu-ray, and HD video
SATA Interface	<ul style="list-style-type: none">■ Supports several optional sections of Serial ATA II: Extensions to Serial ATA 1.0 Specification, Revision 1.0■ Supports SATA transfers to 300 Mbytes/sec.■ Supports mSATA socket
USB Interface	<ul style="list-style-type: none">■ USB host interface with support for 4 x USB 3.0 and 2 x USB 2.0 ports■ All ports are High-Speed, Full-Speed, and Low-Speed capable■ Supports legacy keyboard/mouse software
BIOS	<ul style="list-style-type: none">■ UEFI 128Mbit

1.3.1.3 Others

Serial ports	<ul style="list-style-type: none">■ COM1 ~ COM4: Supports RS-232/422/485 and change mode under BIOS setting ** COM1 ~ COM4 RS-485 supports auto-flow control. COM connector: D-SUB CON. 9P
Ethernet	LAN1 Intel i219, LAN2 Intel i210 <ul style="list-style-type: none">■ Compliant with IEEE 802.3, IEEE 802.3u, IEEE 802.3x, IEEE 802.3y, IEEE 802.ab.■ Supports 10/100/1000 Mbps. LAN Connectors: Phone Jack RJ45 8P 90D(F)
Audio	Audio Codec: Realtek ALC888S: <ul style="list-style-type: none">■ Compliant with HD Audio specifications■ Supports 16/20/24-bit DAC and 16/20/24-bit ADC resolution■ Supports: Line-out, Mic-in Audio Connectors: Ear Phone Jack * 2
Battery backup	<ul style="list-style-type: none">■ BATTERY 3V/210 mAh with WIRE x 1

1.3.2 WISE-PaSS/RMM

Sequence control	Supported
Watchdog timer	Multi Level WDT Programmable 1-255 sec / min
Hardware monitor	CPU Temperature / Input Current / Input Voltage
Power saving	Deep sleep S5 mode
System information	Running HR / Boot record

1.4 Mechanical Specifications

1.4.1 Dimensions

Unit: mm / in: 260 x 54 x 140.2 mm / 10.24 x 2.13 x 5.52 in

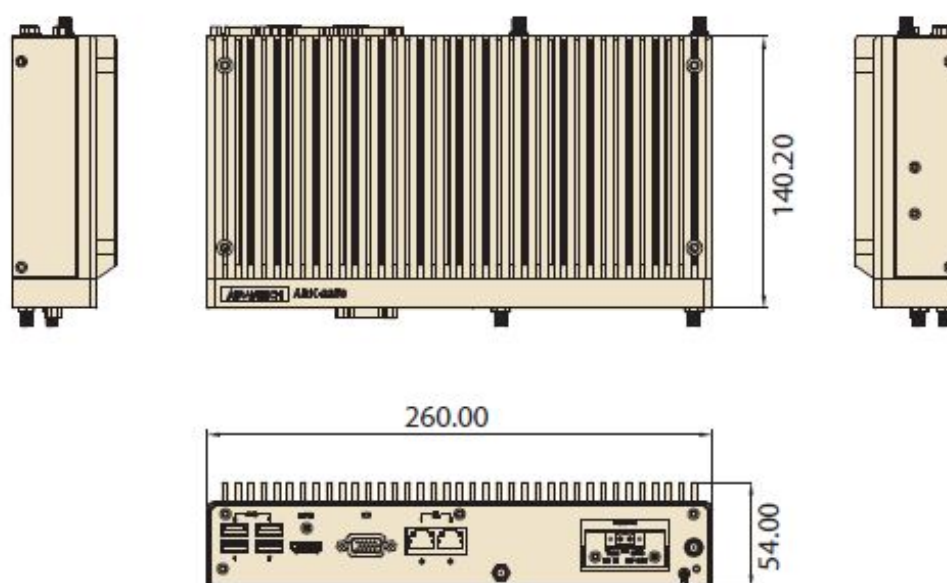

Figure 1.1 ARK-2250 Mechanical Dimension Diagram

1.4.2 Weight

2.3 kg (5.06 lb)

1.5 Power Requirements

1.5.1 System Power

- **Minimum power input:**
 - ARK-2250: DC 12V, 5A

1.5.2 RTC Battery

- Lithium 3 V/210 mA

1.6 Environment Specification

1.6.1 Operating Temperature

- With Industrial Grade SSD/mSATA: -20 ~ 60 °C (-4 ~ 140° F), with air flow, speed = 0.7 m/sec (for single layer)
- With 2.5 inch hard disk: 0 ~ 40 °C (32 ~ 104 °F), with air flow, speed = 0.7 m/sec (for single layer and dual layer)
- With Industrial Grade SSD/mSATA: 0 ~ 40 °C (32 ~ 104 °F), with air flow, speed = 0.7 m/sec (for dual layer)

1.6.2 Relative Humidity

- 95% @ 40 °C/104 °F (non-condensing)

1.6.3 Storage Temperature

- -40 ~ 85 °C (-40 ~ 185 °F)

1.6.4 Vibration During Operation

- When the system is equipped with SSD/mSATA: 3Grms, IEC 60068-2-64, random, 5 ~ 500 Hz, 1hr/axis, x,y,z 3 axes.

1.6.5 Shock During Operation

- When the system is equipped with SSD/mSATA: 30G, IEC 60068-2-27, half sine, 11 ms duration.

1.6.6 Safety

- UL, CB, CCC, BSMI

1.6.7 EMC

- CE, FCC, CCC, BSMI

Chapter 2

H/W Installation

This chapter introduces external I/O and hardware installation for ARK-2250.

2.1 Introduction

The following sections detail the internal jumpers settings and the external connector pin assignments for different applications.

2.2 Jumpers

2.2.1 Jumper Description

You may configure ARK-2250 to match the needs of your application by setting jumpers. A jumper is a metal bridge used to close an electric circuit. It consists of two metal pins and a small metal clip (often protected by a plastic cover) that slides over the pins to connect them. To close a jumper, you connect the pins with the clip. To open a jumper, you remove the clip. Sometimes a jumper will have three pins, labeled 1, 2, and 3. In this case you would connect either pins 1 and 2, or 2 and 3.

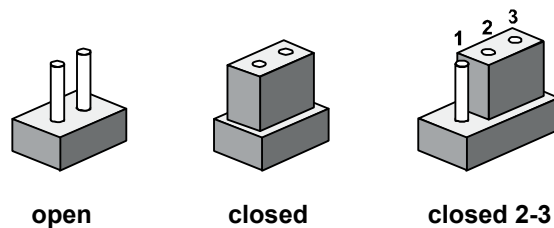

The jumper settings are schematically depicted in this manual as follows.

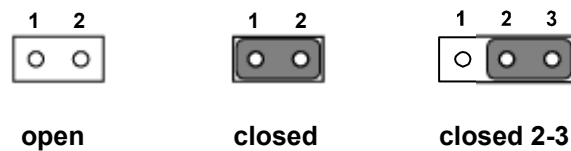

A pair of needle-nose pliers may be helpful when working with jumpers. If you have any doubts about the best hardware configuration for your application, contact your local distributor or sales representative before you make any changes. Generally, you simply need a standard cable to make most connections.

2.2.2 Jumper List

Table 2.1: Jumper Settings

Location	Function
J1	Auto Power On Setting
SW2	Clear CMOS
J5	COM3/COM4 Termination
J6	COM1/COM2 Termination

2.2.3 Jumper Location

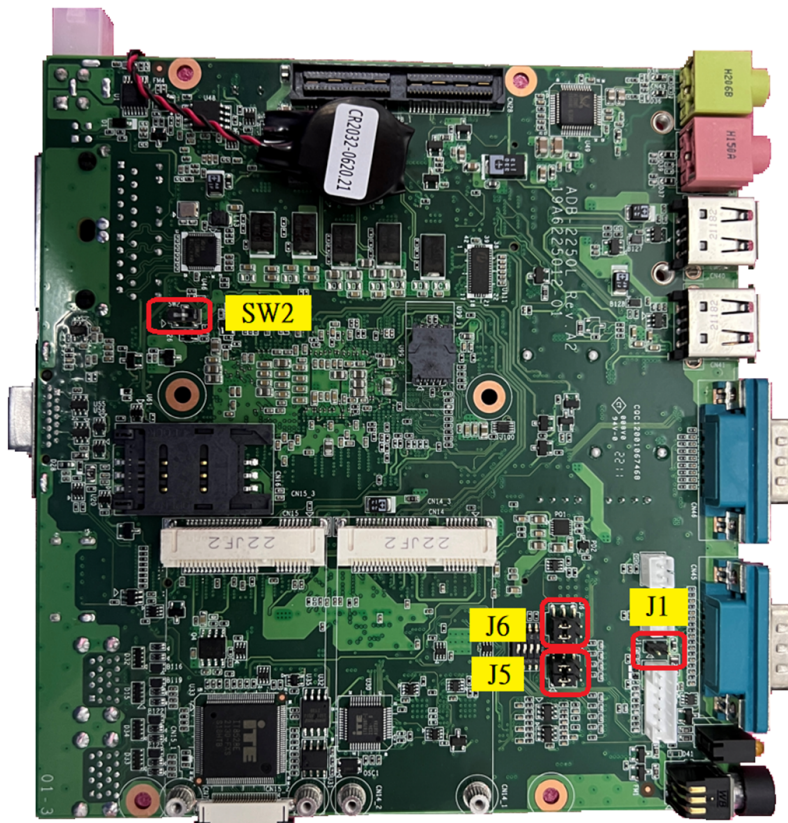

Figure 2.1 Jumper Layout

2.2.4 Jumper Settings

Table 2.2: J1: AT/ATX Mode

PIN	Description
NL	Power On by power button (Default)
1-2	Auto Power On



Table 2.3: SW2: Clear CMOS

PIN	Description
1	Normal operation (Default)
1	Clear CMOS

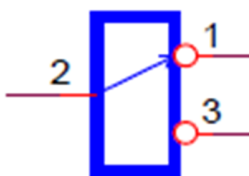

Table 2.4: J5: COM3/COM4 Termination

PIN	Description
2-4 Short	COM3 Enable (Default)
4-6 Short	COM3 Disable
1-3 Short	COM4 Enable (Default)
3-5 Short	COM4 Disable

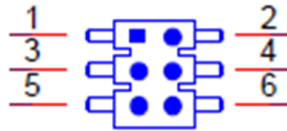
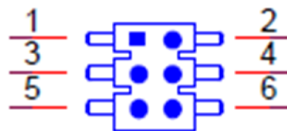

Table 2.5: J6: COM1/COM2 Termination

PIN	Description
2-4 Short	COM2 Enable
4-6 Short	COM2 Disable (Default)
1-3 Short	COM1 Enable
3-5 Short	COM1 Disable (Default)



2.3 Connectors

2.3.1 ARK-2250 External I/O

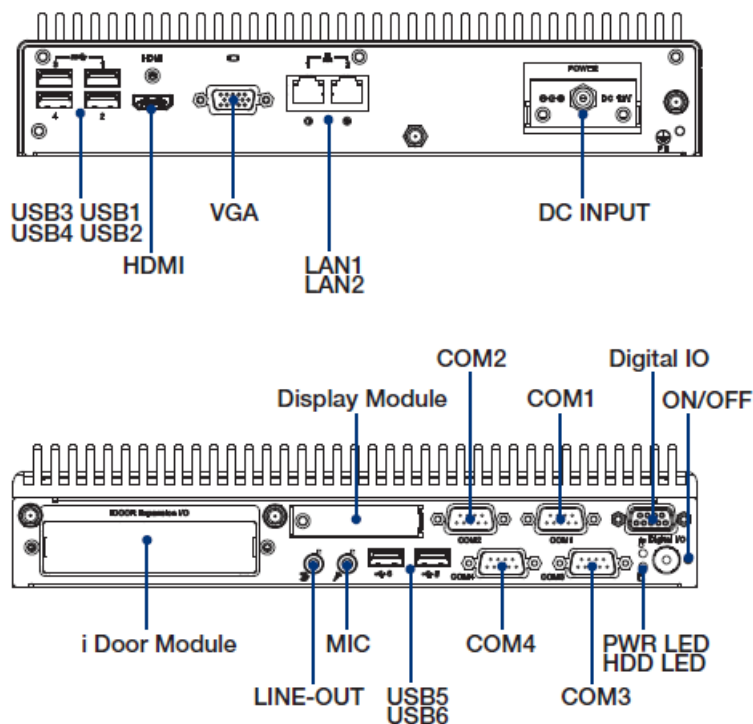

Figure 2.2 ARK-2250 I/O

2.3.1.1 Power On/Off Button

ARK-2250 has a Power On/Off button with LED indicators on the front side that show On status (Green LED) and Off/Suspend status (Orange LED). The Power button supports dual functions: Soft Power On/Off (Instant off or Delay 4 Seconds then off) and Suspend.



Figure 2.3 Power On/Off Button

2.3.1.2 LED Indicators

There are two LEDs on the front panel that indicate system status: The Power LED is for system power status; and HDD LED is for HDD and compact flash disk status.

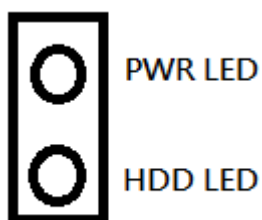

Figure 2.4 LED

2.3.1.3 HDMI Connector

An integrated 19-pin receptacle connector HDMI 1.4a interface is provided. The HDMI link supports resolutions up to 4096 x 2160 @ 24 Hz.

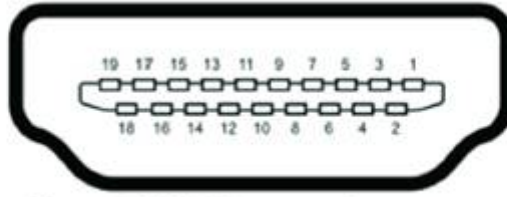

Figure 2.5 HDMI Connector

RS-232		RS-422		RS-485	
Pin	Signal Name	Pin	Signal Name	Pin	Signal Name
1	TMDS Data 2+	2	TMDS Data 2 shield		
3	TMDS Data 2-	4	TMDS Data 1+		
5	TMDS Data 1 shield	6	TMDS Data 1-		
7	TMDS Data 0+	8	TMDS Data 0 shield		
9	TMDS Data 0-	10	TMDS clock+		
11	TMDS clock shield	12	TMDS clock-		
13	CEC	14	Reserved		
15	SCL	16	SDA		
17	DDC/CEC Ground	18	+5V		
19	Hot Plug Detect				

2.3.1.4 VGA Connector

The ARK-2250 provides a high resolution VGA interface connected by a D-sub 15-pin connector to support a VGA CRT monitor. It supports display resolutions of up to 1920 x 1200 @ 60Hz (No hotplug support)

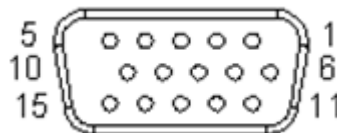

Figure 2.6 VGA Connector

Pin	Signal Name	Pin	Signal Name
1	Red	2	Green
3	Blue	4	NC
5	GND	6	GND
7	GND	8	GND
9	NC	10	GND
11	NC	12	DDAT
13	H-SYNC	14	V-SYNC
15	DCLK		

2.3.1.5 USB 3.0 Connector

The USB port USB port 1, 2, 3, 4 of ARK-2250 supports USB 3.0 interfaces, which provides complete Plug-and-Play and hot swapping capabilities for up to 127 external devices. The USB interface complies with USB UHCI, Rev. 3.0. Please refer to Table. 2.7 for its pin assignments. USB 3.0 connectors contain legacy pins to interface to USB 2.0 devices, and a new set of pins for USB 3.0 connectivity (both sets reside in the same connector).

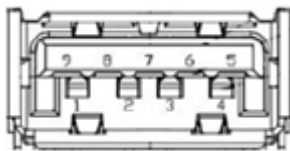

Figure 2.7 USB 3.0 Connector

Pin	Signal name	Pin	Signal name
1	+5V	2	USB_data-
3	USB_data+	4	GND
5	SSRX-	6	SSRX+
7	GND	8	SSTX-
9	SSTX+		

Note! *If your OS is Windows 7, please install the USB 3.0 driver from the Intel website. <https://downloadcenter.intel.com/download/25476/windows-7-usb-3-0-creator-utility>*



2.3.1.6 USB 2.0 Connector

ARK-2250 provides two USB interface connectors. The USB 5, 6 connectors are used to connect any device that conforms to the USB interface. Most digital devices conform to this standard. The USB interface supports Plug and Play capabilities.

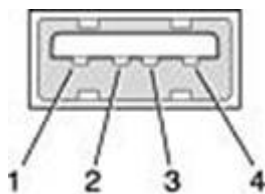

Figure 2.8 USB 2.0 Connector

Pin	Signal name	Pin	Signal name
1	VCC	2	USB_data-
3	USB_data+	4	GND

2.3.1.7 Ethernet Connector (LAN)

ARK-2250 is equipped with two Ethernet controllers that are fully compliant with IEEE 802.3u 10/100/1000 Mbps CSMA/CD standards. LAN1, LAN2 are all equipped with an Intel i219/i210 Ethernet controller. The Ethernet port provides a standard RJ-45 jack connector with LED indicators on the front side to show its Active/Link status (Green LED) and Speed status (Yellow LED).

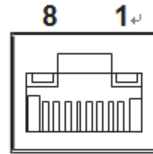

Figure 2.9 Ethernet Connector (LAN)

Pin	10/100/1000 BaseT Signal Name
1	TX+
2	TX-
3	RX+
4	MDI2+
5	MDI2-
6	RX-
7	MDI3+
8	MDI3-

2.3.1.8 Audio Connector

ARK-2250 offers stereo audio ports via 2 x phone jack connectors — Line_Out, Mic_In. The audio chip is controlled by ALC888S, and it's compliant with Azalea standards.

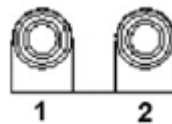
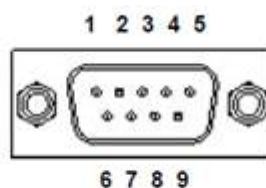

Figure 2.10 Audio Connector

Pin	Audio Signal Name
1	Line out
2	Mic in

2.3.1.9 COM Connector

ARK-2250 provides four D-sub 9-pin connectors, which offers RS232/422/485 serial communication interface ports. The default setting is RS-232, if you want to use RS-422/485, you can find the BIOS manual and change settings.



	RS-232	RS-422	RS-485
Pin	Signal Name	Signal Name	Signal Name
1	DCD	Tx-	DATA-
2	RxD	Tx+	DATA+
3	TxD	Rx+	NC
4	DTR	Rx-	NC
5	GND	GND	GND
6	DSR	NC	NC
7	RTS	NC	NC
8	CTS	NC	NC
9	RI	NC	NC

Note! NC represents “No Connection”.



2.3.1.10 GPIO Connector

ARK-2250 provides 8-bit GPIO, please refer to the pin definition.

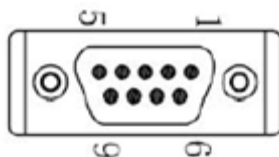

Figure 2.11 GPIO Connector

Pin	Signal
1	DIO bit 0
2	DIO bit 1
3	DIO bit 2
4	DIO bit 3
5	DIO bit 4
6	DIO bit 5
7	DIO bit 6
8	DIO bit 7
9	GND

2.4 Installation

2.4.1 Memory Installation

1. Unscrew the 4 x screws on the top cover. (Please use the tool in the accessory box.)



2. Remove the top cover and install the memory into the memory socket.



3. Return the top cover to the original position.

2.4.2 HDD/SSD Installation

1. Unscrew the 4 x screws on the bottom cover, and the 4 x screws on both sides of ARK-2250.



2. Unscrew the 4 x screws on the HDD bay.

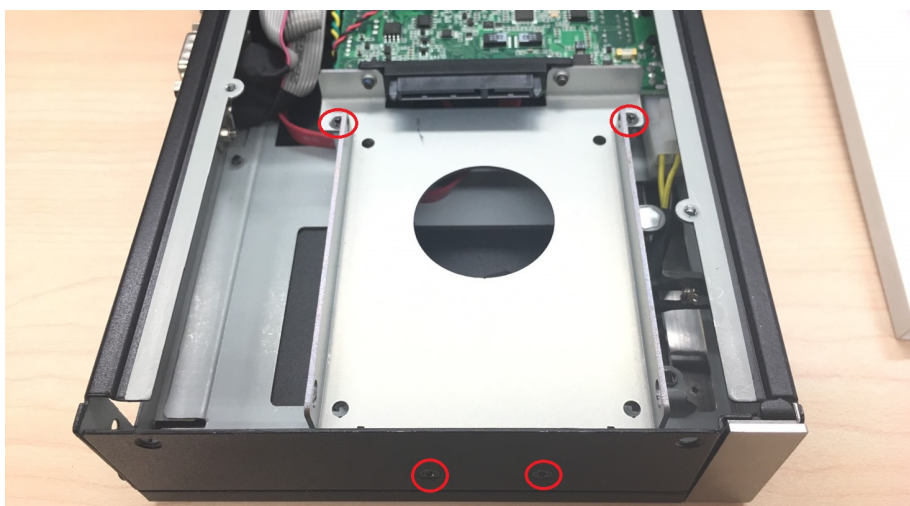

3. Install the HDD/SSD into the HDD bay, and fix the HDD onto the bracket.



4. Fix the 4 x screws back onto the HDD bay.



5. Put the bottom cover back and fix the 8 x screws back onto the system.

2.4.3 mSATA Installation

1. Unscrew the 4 screws on the bottom cover, and the 4 screws on both sides of ARK-2250.



2. Put the mSATA module onto the mSATA slot (CN15), and fasten the 2 screws back onto the mSATA module.



3. Put the bottom cover back and fasten the 8 screws back onto the system.

2.4.4 Power Module (MIOe-PWR2) Installation (Optional)

1. Remove the 4 screws on the top cover. (Please use the tool in the accessory box.)



2. Remove the 2 screws on the power bracket for the original DC jack on the front panel.



3. Unscrew the 4 screws on the bottom cover and on both sides of ARK-2250.



4. Remove the original internal power cable from the M/B.

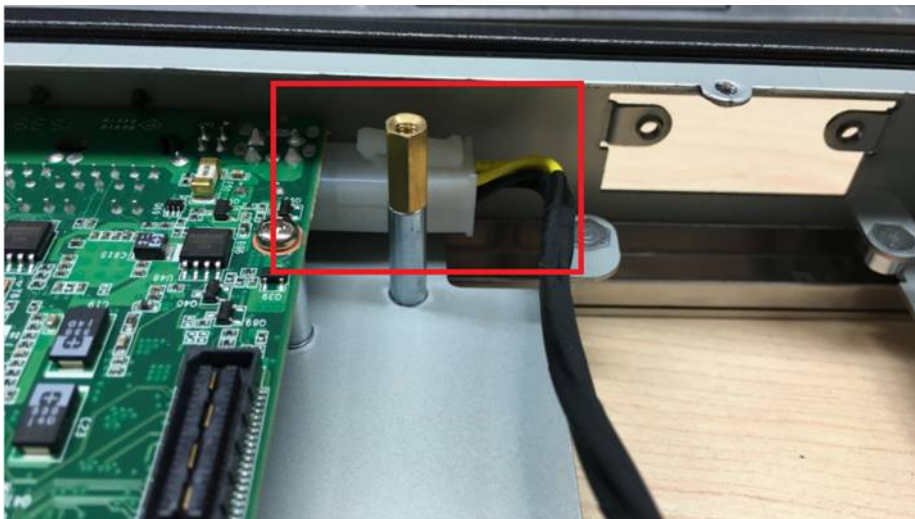

5. Link the MIOe-PWR2 internal power cable from M/B to the power board.

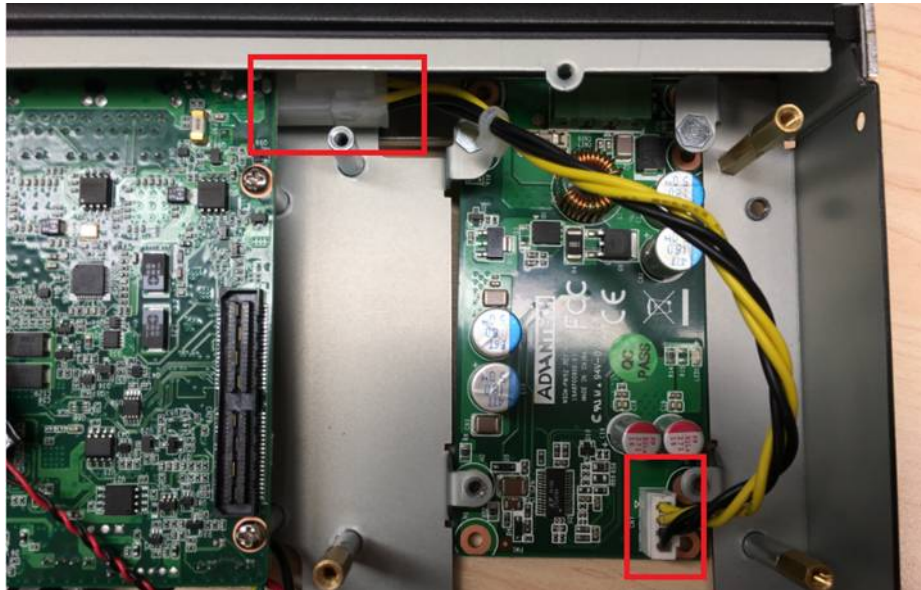

6. Turn to the top side, and fasten the 4 screws for the power board, and tape 3 thermal pads on the red marks.

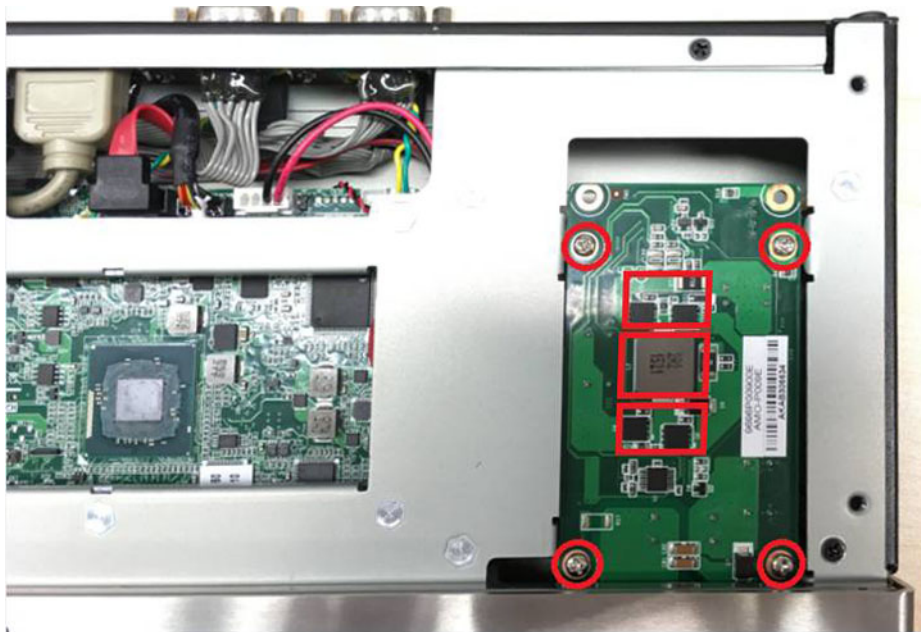

7. Screw in the new power bracket for MIOe-PWR2 on the front panel.



8. Put on the bottom cover and the 8 screws back onto the system.
9. Put on the top cover and the 4 screws.

2.4.5 iDoor Module Installation (Option)

Please refer to iDoor modules support on datasheet.

2.4.6 2nd Layer MIOe Module Installation (Option)

Please refer to ARK-Plus module support on datasheet.

2.4.7 Wall Mount Installation (Option)

1. Unscrew the 4 screws on both sides of ARK-2250L



2. Screw wall mount brackets on both sides of ARK-2250L



Note! 4 x 5 mm (0.19 in) M3 type screws are provided to secure the mounting kit and unit. Use a suitable mounting apparatus to avoid risk of injury.



Remarque! Vis de type M3, longueur 5 mm x 4 fournies pour la fixation du kit de montage et de l'unité. Utilisez un appareil de montage approprié pour éviter tout risque de blessure.



Chapter 3

BIOS Settings

Users can modify BIOS settings and control the various system features with the AMIBIOS setup program. This chapter describes the basic navigation of ARK-2250 BIOS setup screens.



AMIBIOS ROM has a built-in setup program that allows users to modify the basic system configuration. This information is stored in flash ROM so it retains the setup information when the power is turned off.

3.1 Entering Setup

Turn on ARK-2250 and then press <F2> or to enter setup menu.

3.2 Main

When users first enter BIOS setup utility, users will enter Main setup screen. Users can always return to Main setup screen by selecting the Main tab. There are two Main setup options. They are described in this section. The Main BIOS setup screen is shown below.



The Main BIOS setup screen has two main frames. The left frame displays all the options that can be configured. Grayed-out options cannot be configured; options in blue can. The right frame displays the key legend.

Above the key legend is an area reserved for a test message. When an option is selected in the left frame, it is highlighted in white. Often a test message will accompany it.

■ **System Date / System Time**

Use this option to change the system time and date. Highlight System Date or System Time using the <Arrow> keys. Enter new values through the keyboard. Press then <Tab> key or the <Arrow> keys to move between fields. The date must be entered in MM/DD/YY format. The time must be entered in HH:MM:SS format.

3.3 Advanced

Select Advanced tab from the ARK-2250 setup screen to enter the Advanced BIOS setup screen. Users can select any of the items in the left frame of the screen, such as CPU Configuration, to go to the sub menu for that item. Users can display an Advanced BIOS setup option by highlighting it using the <Arrow> keys. All Advanced BIOS setup options are described in this section. The Advanced BIOS setup screens are shown below. The sub menus are described in the following pages.

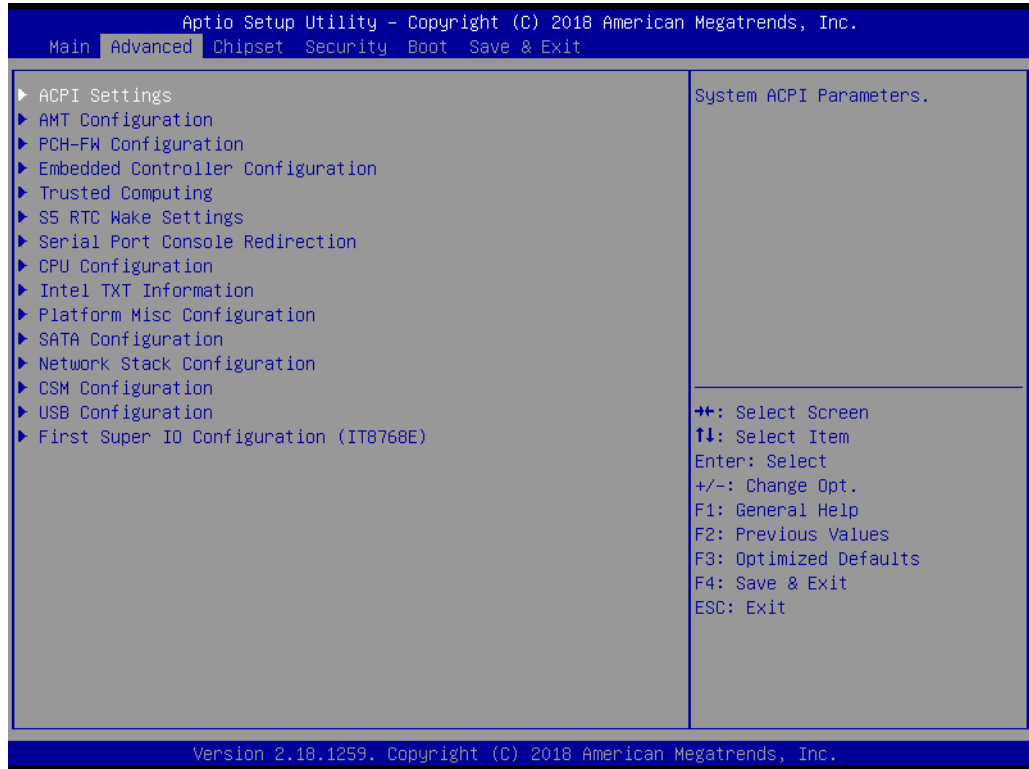

3.3.1 ACPI Settings



- **Enable ACPI Auto Configuration**
This item allows users to enable or disable BIOS ACPI auto configuration.
- **Enable Hibernation**
This item allows users to enable or disable hibernation.
- **ACPI Sleep State**
This item allows users to set the ACPI sleep state.
- **Lock Legacy Resources**
This item allows users to lock legacy device resources.
- **S3 Video Repost**
This item allows users to enable or disable S3 Video Repost.

3.3.2 AMT Configuration

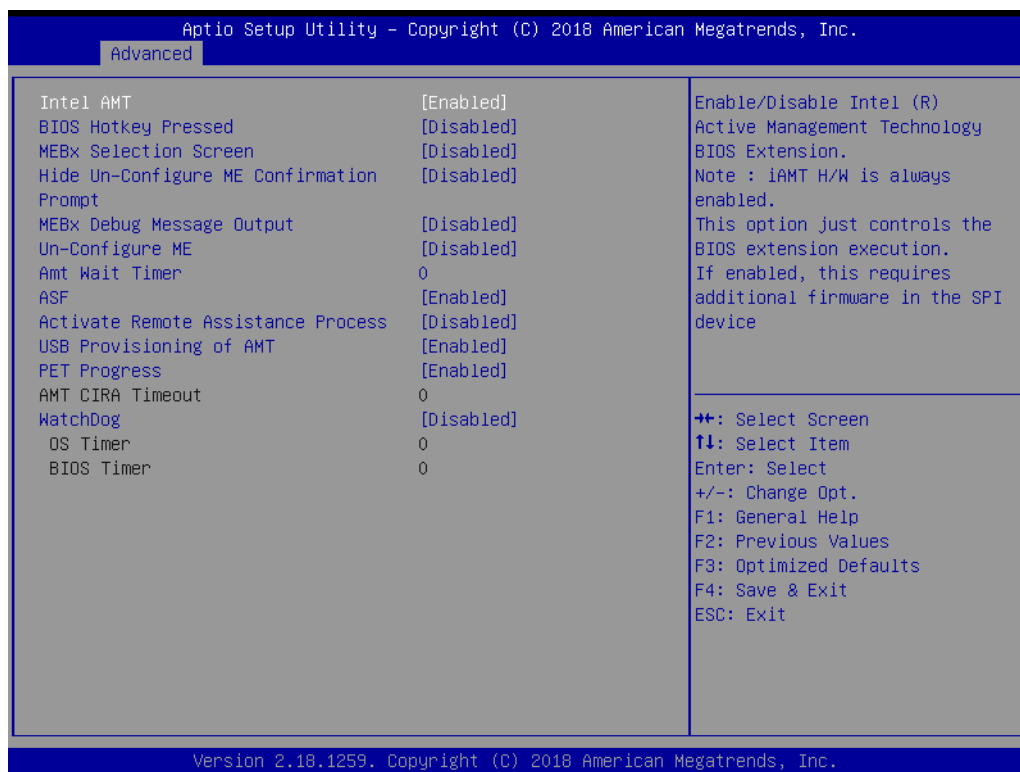

- **Intel AMT**
This item allows user to enable/disable Intel® Active Management Technology BIOS Extension.
- **BIOS Hotkey Pressed**
This item allows users to enable/disable BIOS hotkey press.
- **MEBx Selection Screen**
This item allows users to enable/disable MEBx selection screen.
- **Hide Un-Configure ME Confirmation Prompt**
This item allows users to hide Un-Configure ME without password Confirmation Prompt.
- **MEBx Debug Message Output**
This item allows users to enable/disable MEBx debug message output.
- **Un-Configure ME**
This item allows user to Un-Configure ME without password.
- **Amt Wait Timer**
This item allows user to set timer to wait before sending ASF_GET_BOOT_OPTIONS.
- **ASF**
This item allows users to enable/disable Alert Specification Format.
- **Activate Remote Assistance Process**
This item allows users to trigger CIRA boot.
- **USB Provisioning of AMT**
This item allows users to enable/disable of AMT USB Provisioning.
- **PET Progress**
This item allows users to enable/disable PET Events progress to receive PET events.
- **Watchdog**
This item allows users to enable/disable Watchdog Timer.

3.3.3 PCH-FW Configuration

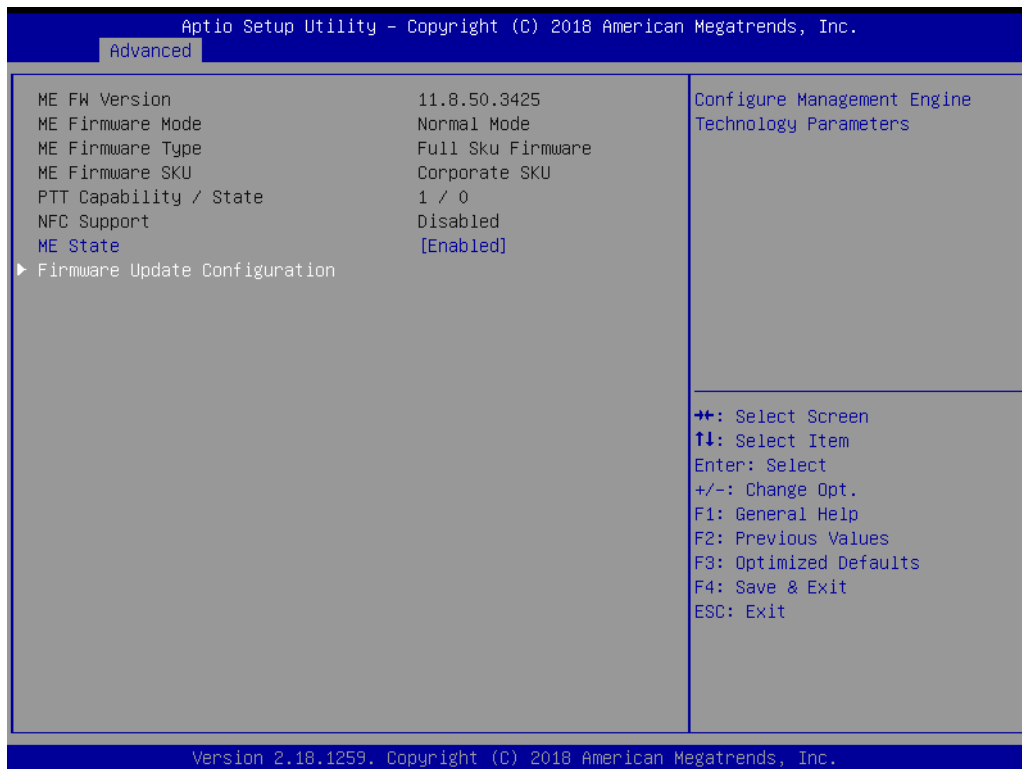

- **ME State**
This item allows users to enable or disable ME State.

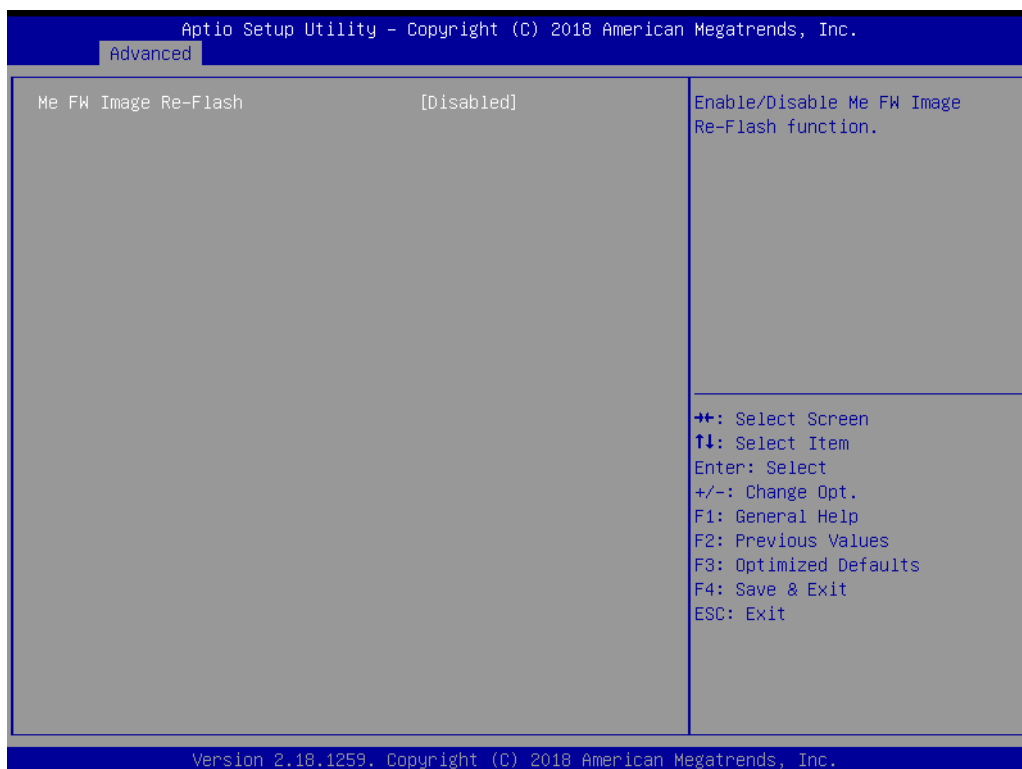

- **Firmware Update Configuration**
This item allows users to enable or disable ME FW Image Re-Flash.

3.3.4 Embedded Controller Configuration

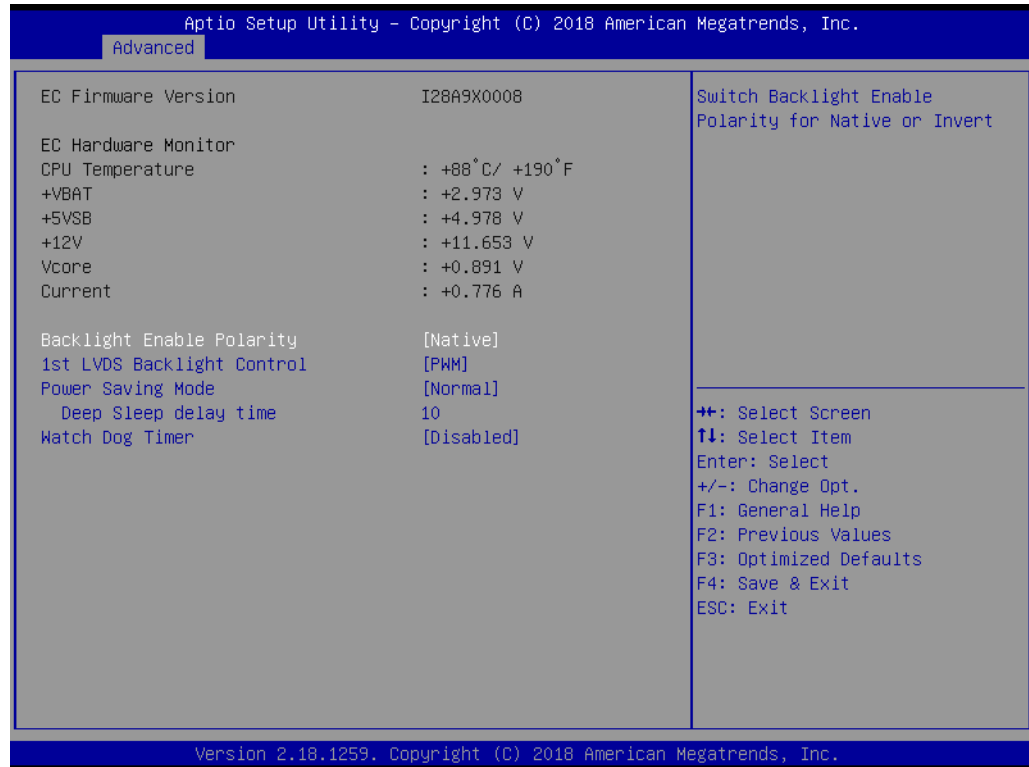

The Embedded Controller Configuration displays comprehensive system temperature/voltage information.

- **Backlight Enable Polarity**
Switch Backlight Polarity for Native or Invert
- **1st LVDS Backlight Control**
Switch Backlight Control to PWM or DC mode
- **Power Saving Mode**
This item allows users to set board's power saving mode when off
- **Watch Dog Timer**
This item allows users to enable or disable Watchdog Timer

3.3.5 Trusted Computing

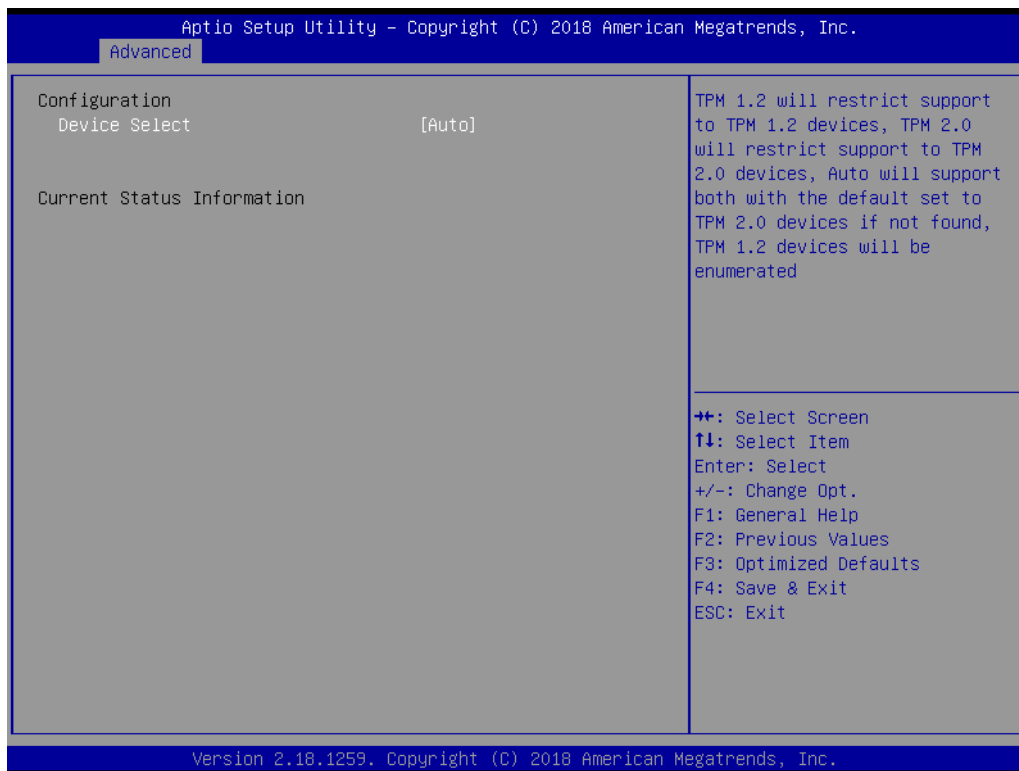

- **Device Select**

This item allows users to select TPM device type: 1.2 / 2.0 / Auto.

3.3.6 S5 RTC Wake Settings

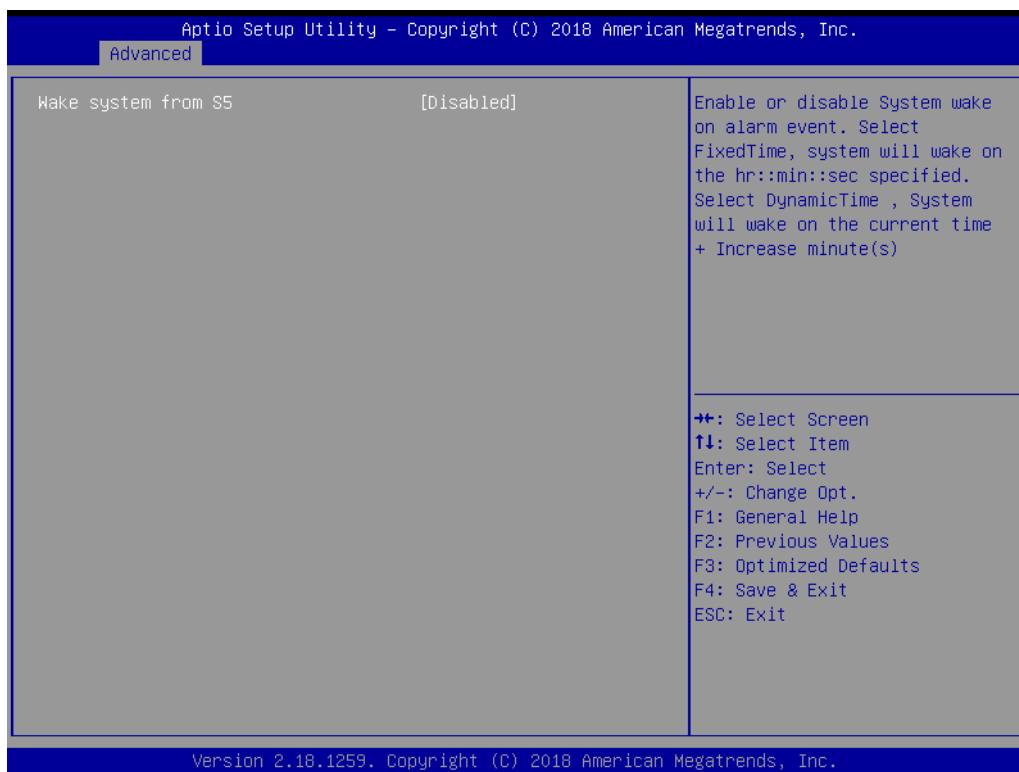

- **Wake system from S5**
Enable or disable system wake on alarm event. Select fixed time, system will wake on the hr:min:sec specified.

3.3.7 Serial Port Console Redirection

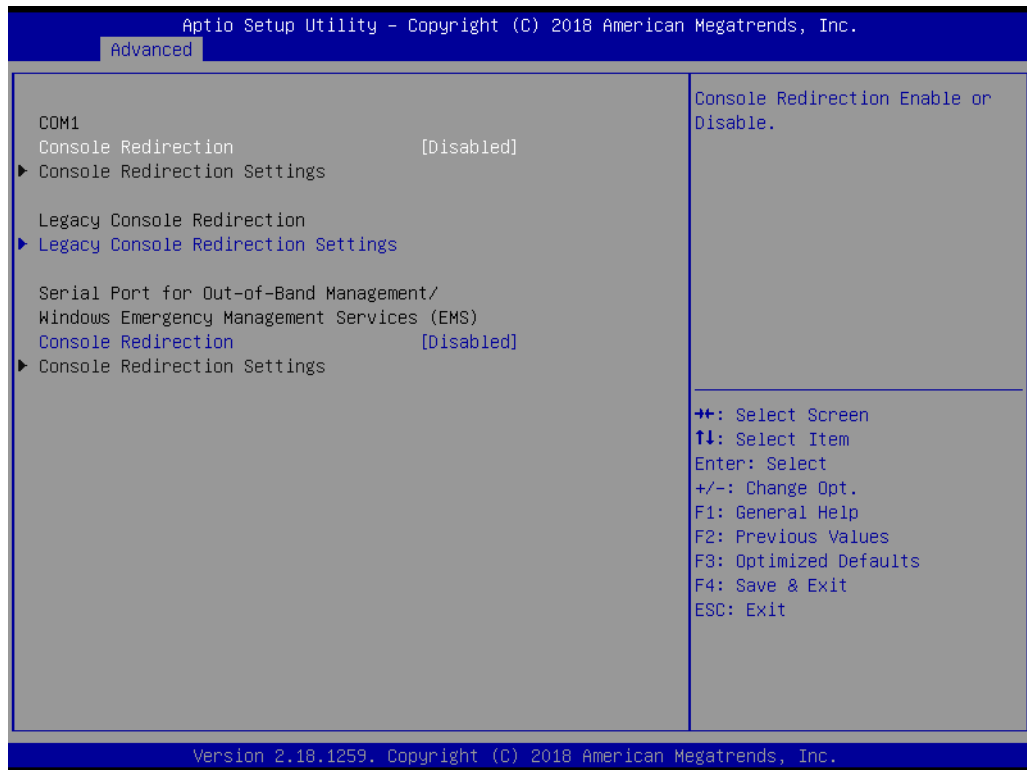

- **Console Redirection**
This item allows users to enable or disable console redirection for Microsoft Windows Emergency Management Services (EMS).
- **Console Redirection Settings**
This item allows users to configure console redirection detail settings.

3.3.8 CPU Configuration

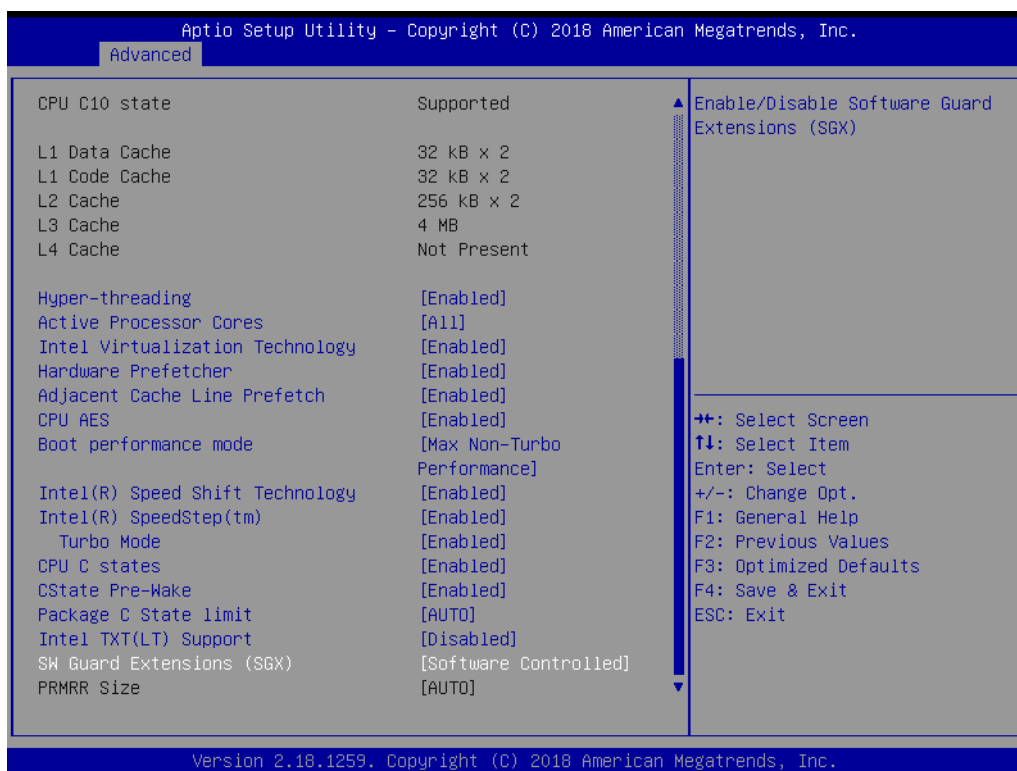
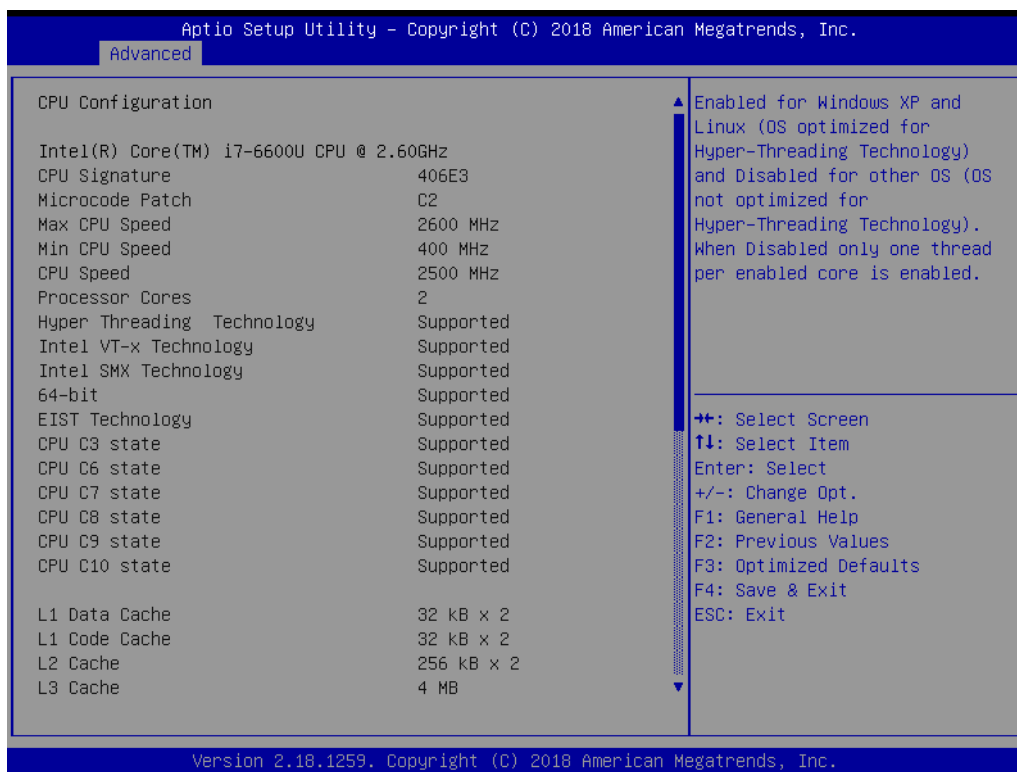

- **Hyper-threading**
This item allows users to enable/disable Hyper-Threading Technology.
- **Active Processor Cores**
This item shows number of cores to enable in each processor package.

-
- **Intel Virtualization Technology**
When this item is enabled, a VMM can utilize the additional hardware capabilities provided by Vanderpool Technology.
 - **Hardware Prefetcher**
This item allows users to turn on/off the MLC streamer prefetcher
 - **Adjacent Cache Line Prefetch**
This item allows users to turn on/off prefetching of adjacent cache lines.
 - **CPU AES**
This item allows users to enable/disable CPU Advanced Encryption Standard instructions.
 - **Boot performance mode**
This item allows users to select the performance state that the BIOS will set before OS handoff.
 - **Intel® Speed Shift Technology**
This item allows users to enable/disable Intel® Speed Shift Technology support.
 - **Intel® SpeedStep™**
This item let users to allow more than two frequency ranges to be supported.
 - **Turbo Mode**
This item allows users to enable/disable Turbo Mode.
 - **CPU C states**
This item allows users to enable or disable CPU C states.
 - **CState Pre-Wake**
When this item is disabled, it sets bit 30 of POWER_CTL MSR(0x1FC) to 1 to disable the Cstate Pre-Wake.
 - **Package C State limit**
This item allows users to enable/disable Package C State limit.
 - **Intel TXT(LT) Support**
This item allows users to enables/disables Intel(R) TXT(LT) support.
 - **SW Guard Extensions (SGX)**
This item allows users to enable/disable Software Guard Extensions (SGX).

3.3.9 Intel TXT Information

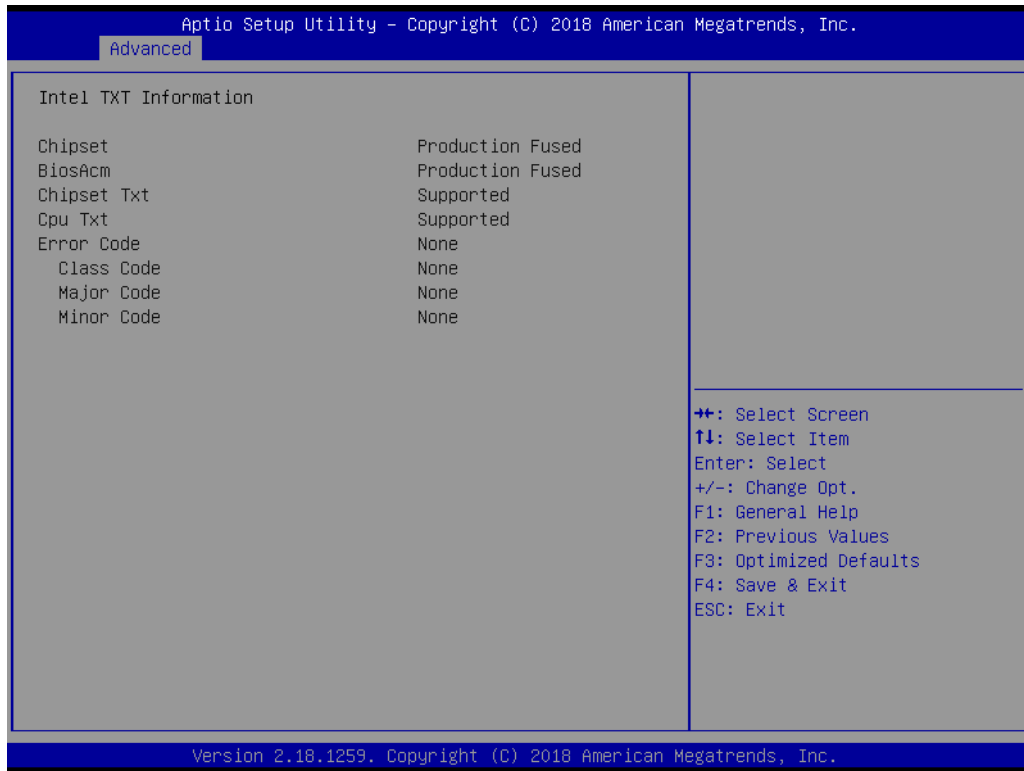

This page provides TXT status information.

3.3.10 Platform Misc Configuration



- **Native PCIE Enable**
This item allows users to enable/disable PCI Express Native Support. This feature is only available in Vista.
- **Native ASPM**
When this item is enabled, Vista will control the ASPM support for the device. When it is disabled, the BIOS will.

3.3.11 SATA Configuration

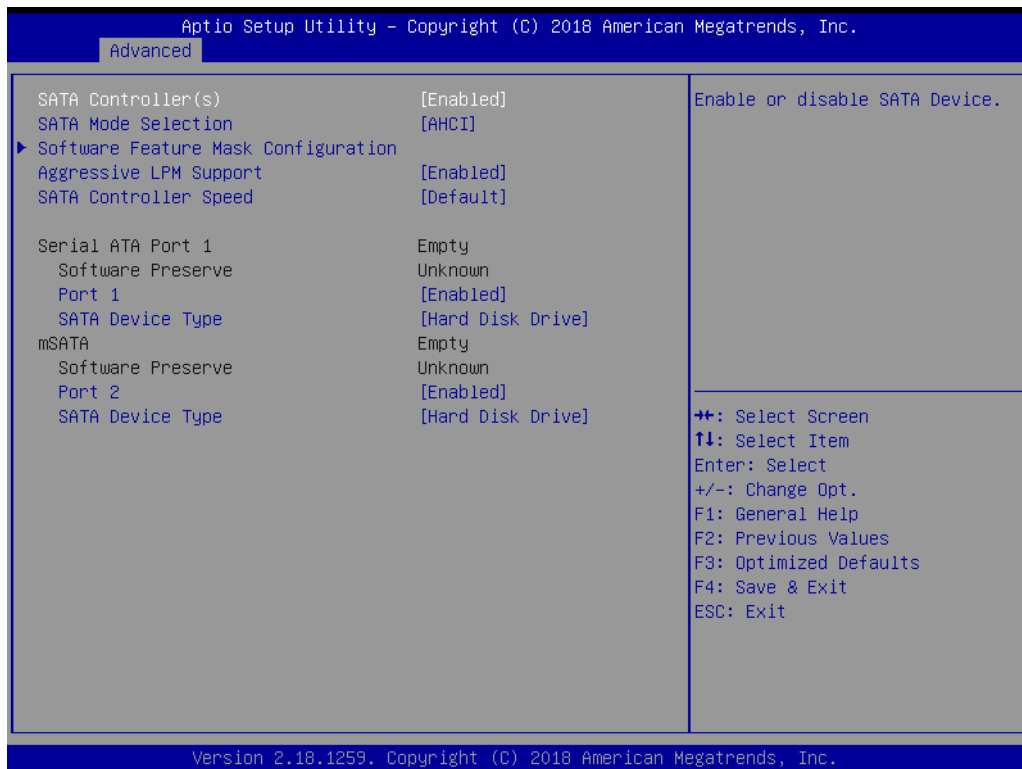

- **SATA Controller(s)**
This item allows users to enable/disable SATA Device.
- **SATA Mode Selection**
This item determines how SATA controller(s) operate.
- **Aggressive LPM Support**
This item enables PCH to aggressively enter link power state.
- **SATA Controller Speed**
This item indicates the maximum speed the SATA controller can support.
- **Port 1/Port 2**
This item allows users to enable/disable SATA Port.
- **SATA Device Type**
This item identifies the SATA port is connected to Solid State Drive or Hard Disk Drive.

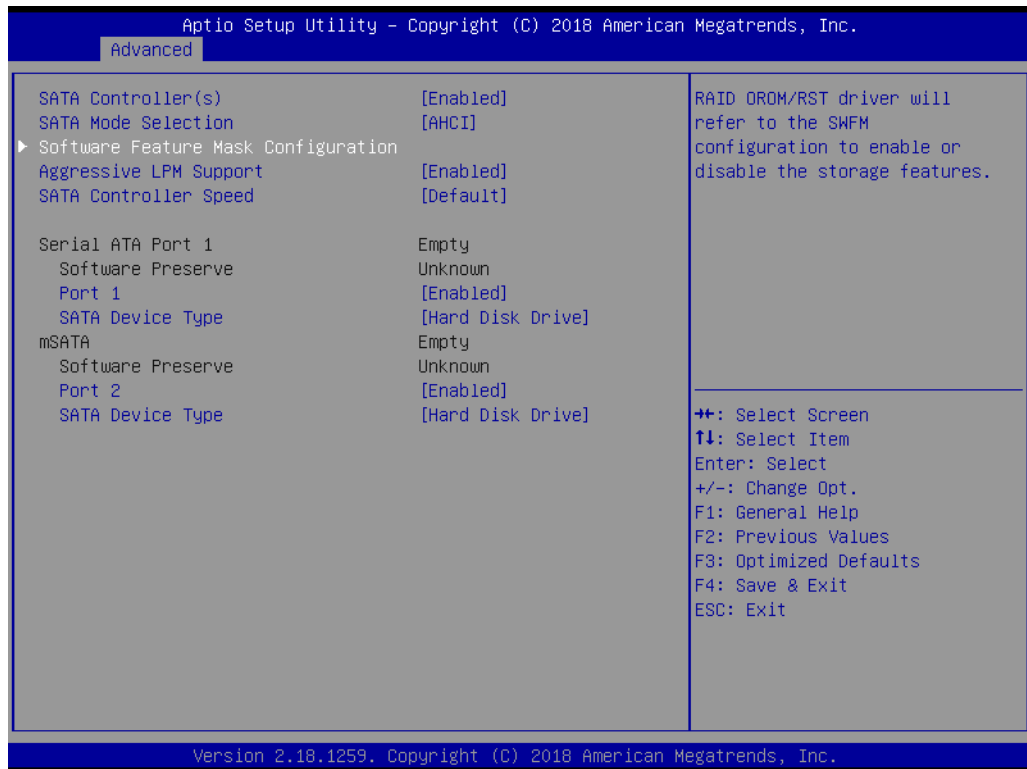

- **RAID0**
This item allows users to enable/disable RAID0 feature.
- **RAID1**
This item allows users to enable/disable RAID1 feature.
- **RAID10**
This item allows users to enable/disable RAID10 feature.

- **RAID5**
This item allows users to enable/disable RAID5 feature.
- **Intel Rapid Recovery Technology**
This item allows users to enable/disable Intel Rapid Recovery Technology.
- **OROM UI and BANNER**
When it is enabled, the OROM UI is shown. Otherwise, no OROM banner or information will be displayed if all disks and RAID volumes are normal.
- **HDD Unlock**
When it is enabled, indicates that the HDD password unlock in the OS is enabled.
- **LED Locate**
When it is enabled, it indicates that the LED/SGPIO hardware is attached and *ping to locate* feature is enabled on the OS.
- **IRRT Only on eSATA**
When it is enabled, only IRRT volumes can span internal and eSATA drives.
- **Smart Response Technology**
This item allows users to enable/disable Smart Response Technology.
- **OROM UI Normal Delay**
This item lets users select the delay time of the OROM UI Splash Screen in a normal status.
- **RST Force Form**
This item allows users to enable/disable form for Intel Rapid Storage Technology.

3.3.12 Network Stack Configuration



- **Network Stack**
Enable/Disable UEFI Network Stack.

3.3.13 CSM Configuration



- **CSM Support**
Enable/Disable CSM support
- **GateA20 Active**
Upon Request - G20 can be disabled using BIOS services. We suggest that users do not disable GA20 as this option is useful when any RT code is executed above 1MB.
- **Option ROM Messages**
Set display mode for Option ROM.
- **INT19 Trap Response**
BIOS reaction on INT19 trapping by Option ROM: Immediate - execute the trap right away; Postponed - execute the trap during legacy boot.
- **Boot option filter**
This option controls Legacy/UEFI ROM priority.
- **Network**
Controls the execution of UEFI and Legacy PXE OpROM.
- **Storage**
Controls the execution of UEFI and Legacy Storage OpROM.
- **Video**
Controls the execution of UEFI and Legacy Video OpROM.
- **Other PCI devices**
Determines OpROM execution policy for devices other than Network, Storage, or Video.

3.3.14 USB Configuration

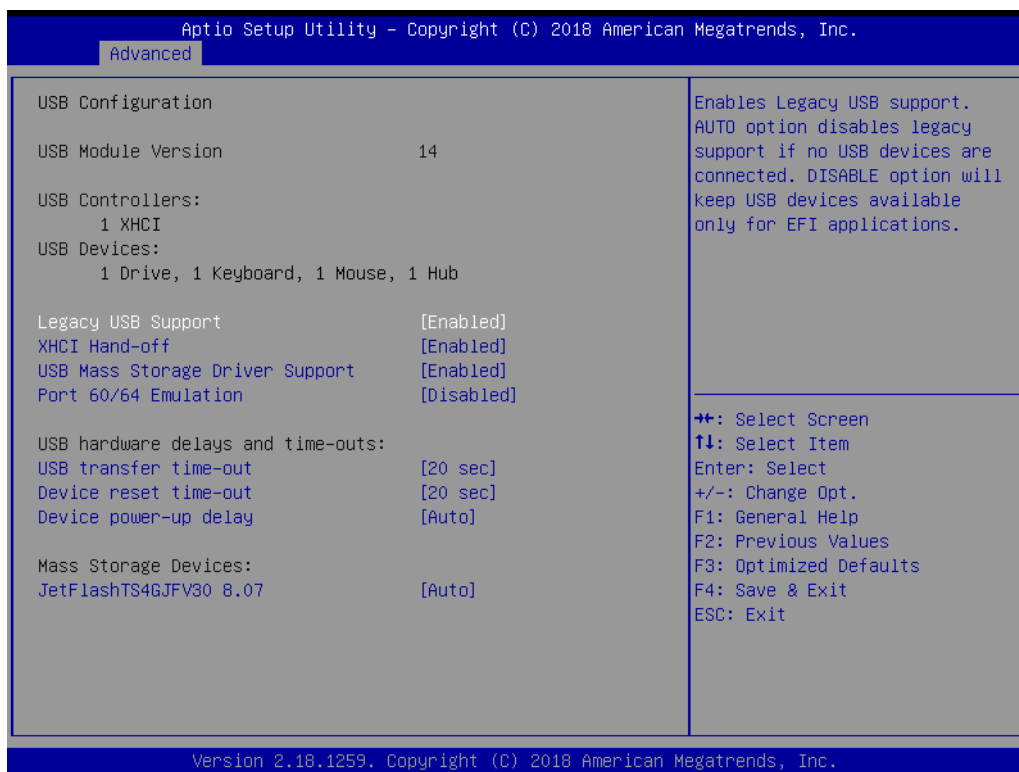

- **Legacy USB Support**
Enable Legacy USB support. AUTO option disables legacy support if no USB devices are connected. DISABLE option keeps USB devices available only for EFI applications.
- **XHI Hand-off**
This is a workaround for OS without XHCI hand-off support. The XHCI ownership change should be claimed by XHCI driver.
- **USB Mass Storage Driver Support**
Enable/Disable USB Mass Storage Device Support.
- **Port 60/64 Emulation**
Enable/Disable Port 60/64 Emulation.
- **USB transfer time-out**
Time-out value for control, bulk, and interrupt transfers.
- **Device rest time-out**
USB mass storage device start until command time-out.
- **Device power-up delay**
Maximum time the device will take before it properly reports itself to the host controller. "Auto" uses default value: for Root port it is 100ms, for a Hub port, the delay is taken from Hub descriptor.

3.3.15 First Super IO Configuration

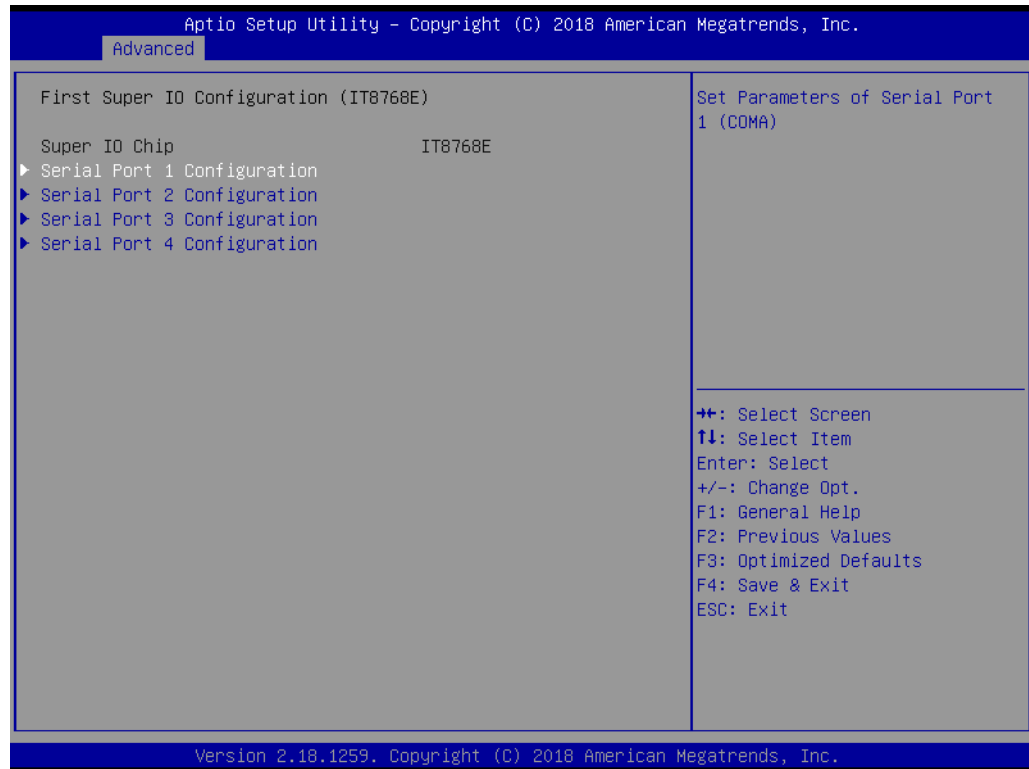

- **Serial Port 1 Configuration**
Set parameters of serial port 1
- **Serial Port 2 Configuration**
Set parameters of serial port 2
- **Serial Port 3 Configuration**
Set parameters of serial port 3
- **Serial Port 4 Configuration**
Set parameters of serial port 4

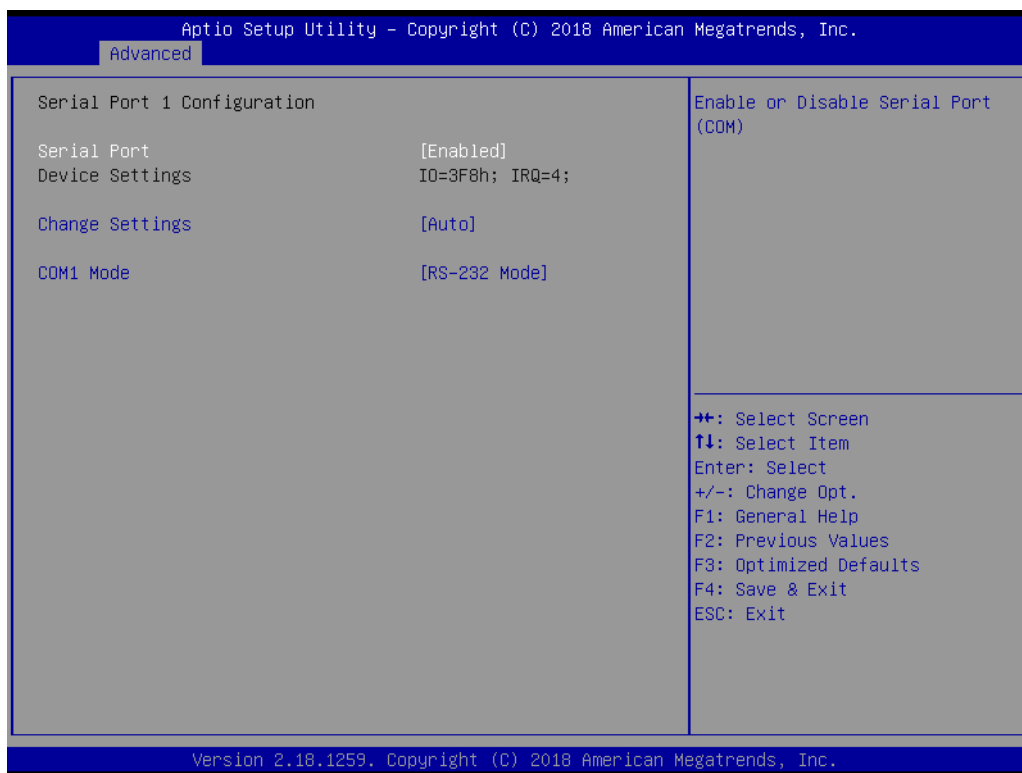

- **Serial Port**
Enable or Disable Serial Port (COM).
- **Change Settings**
Select the optimal settings for Super IO Device.
- **COM Mode**
Select communication type as RS-232/422/485.

3.4 Chipset

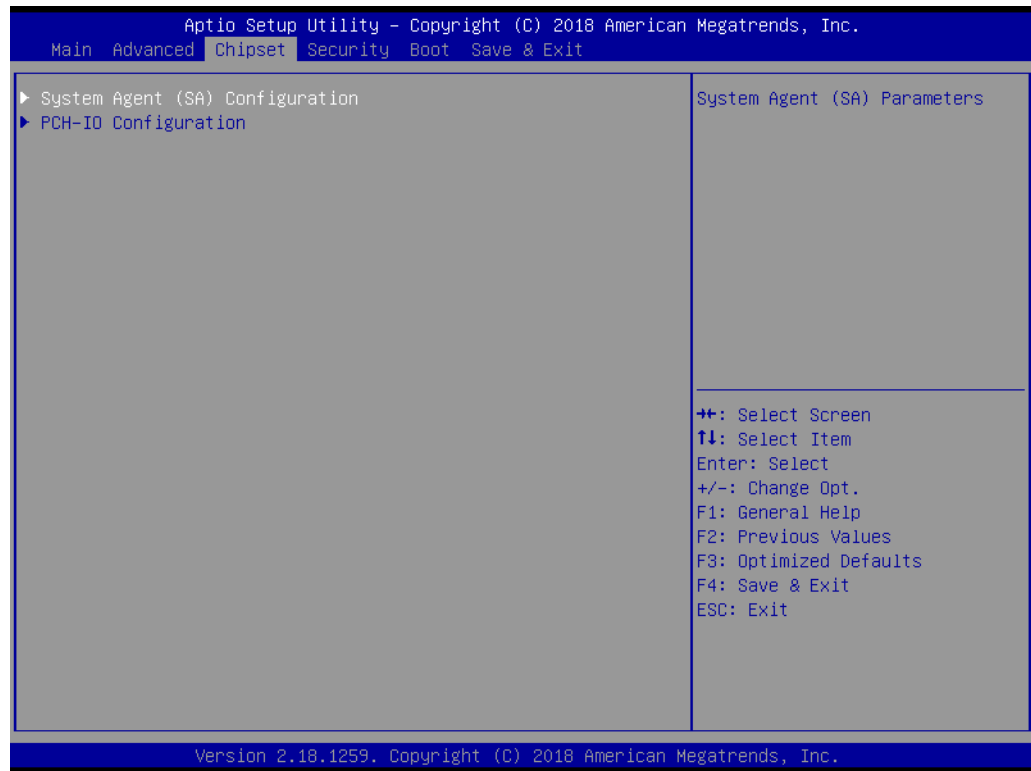

- **System Agent (SA) Configuration**
Details of System Agent Configuration
- **PCH-IO Configuration**
Details of PCH-IO Configuration

3.4.1 System Agent Configuration



- **Above 4GB MMIO BIOS assignment**
This item allows users to enable/disable above 4GB Memory MappedIO BIOS assignment. This is disabled automatically when Aperture Size is set to 2048MB.

3.4.1.1 Graphic Configuration

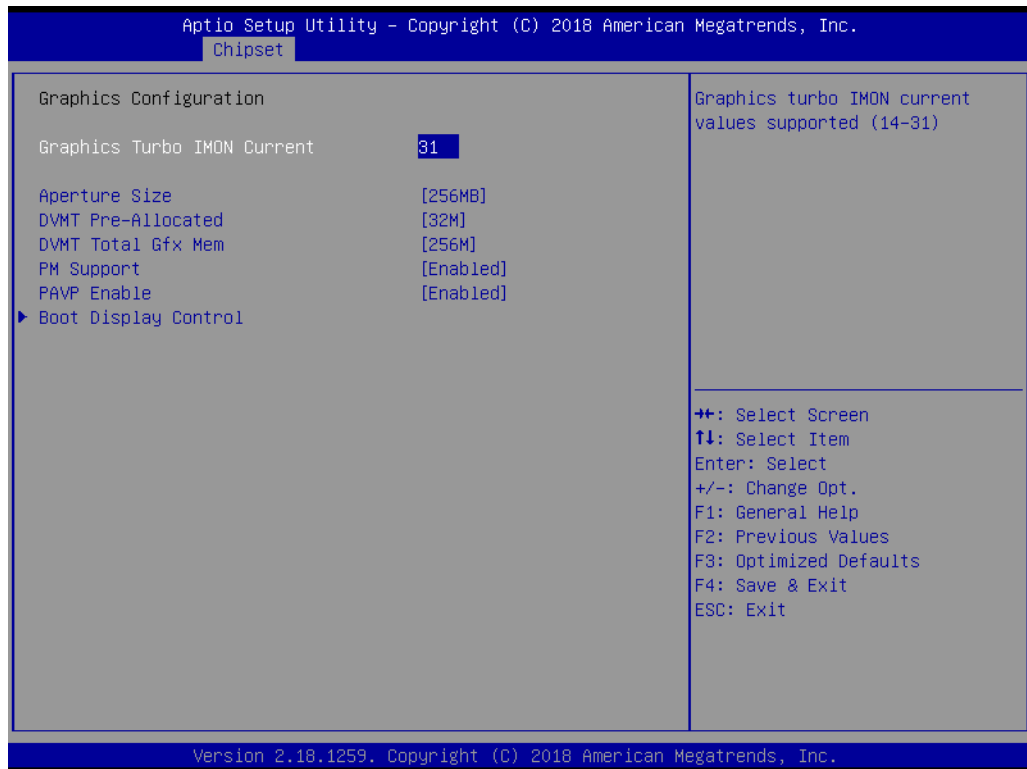

- **Graphics Turbo IMON Current**
Graphics turbo IMON current values supported (14-31).
- **Boot Display Control**

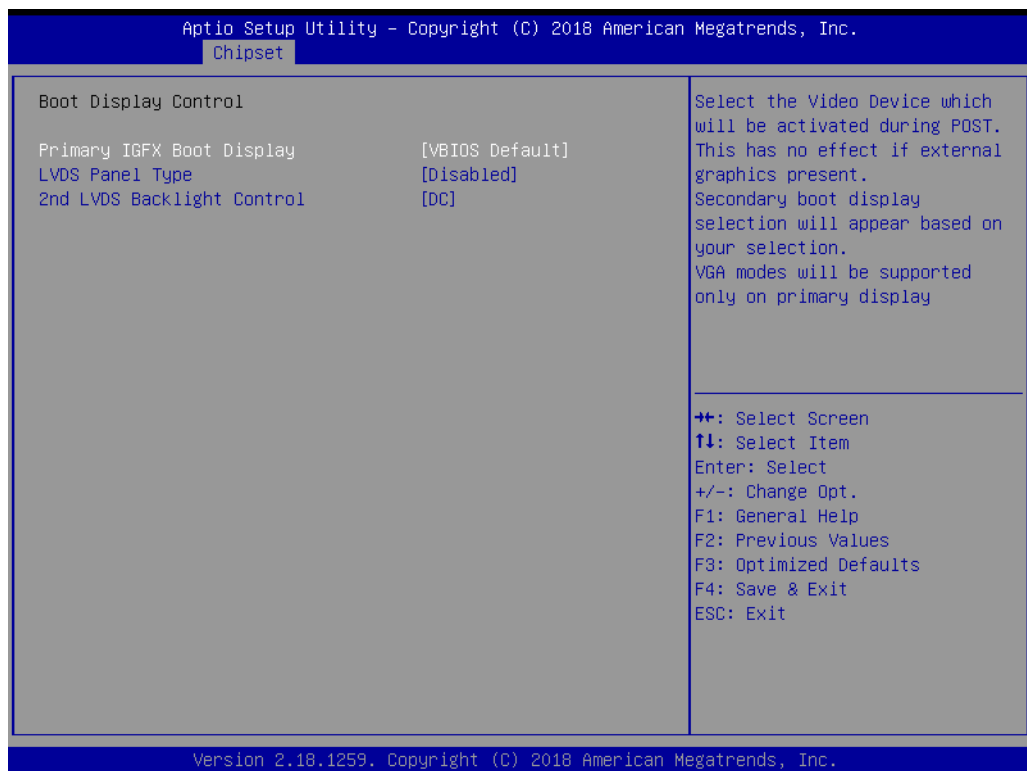

- **Primary IGFX Boot Display**
This item lets users select the Video Device which will be activated during POST.

- LVDS Panel Type
This item lets user select the LCD Panel Type.
- 2nd LVDS Backlight Control
This item lets users switch Backlight Control for PWM or DC mode.

3.4.1.2 Memory Configuration

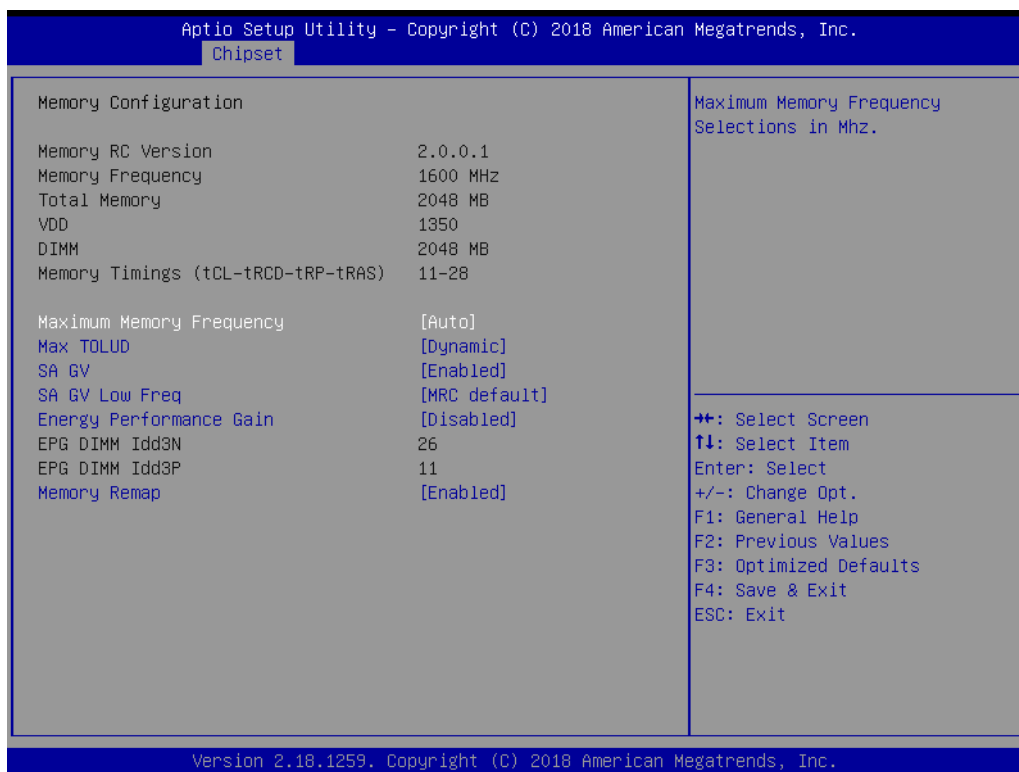

- **Maximum Memory Frequency**
This item lets users set Maximum Memory Frequency Selections in Mhz.
- **Max TOLUD**
This item lets users set Maximum Value of TOLUD. Dynamic assignment will adjust TOLUD automatically based on largest MMIO length of installed graphics controller.
- **SA GV**
This item is System Agent Geyserville. Fixed Low/High: SA GV disabled, MRC only runs tasks from Low or High point.
- **SA GV Low Freq**
Set frequency for low point. Default 1067 for LPDDR3/DDR3, 1333 for DDR4.
- **Energy Performance Gain**
This item allows users to enable/disable Energy Performance Gain.
- **Memory Remap**
This item allows users to enable/disable Memory Remap above 4GB.

3.4.1.3 GT - Power Management Control

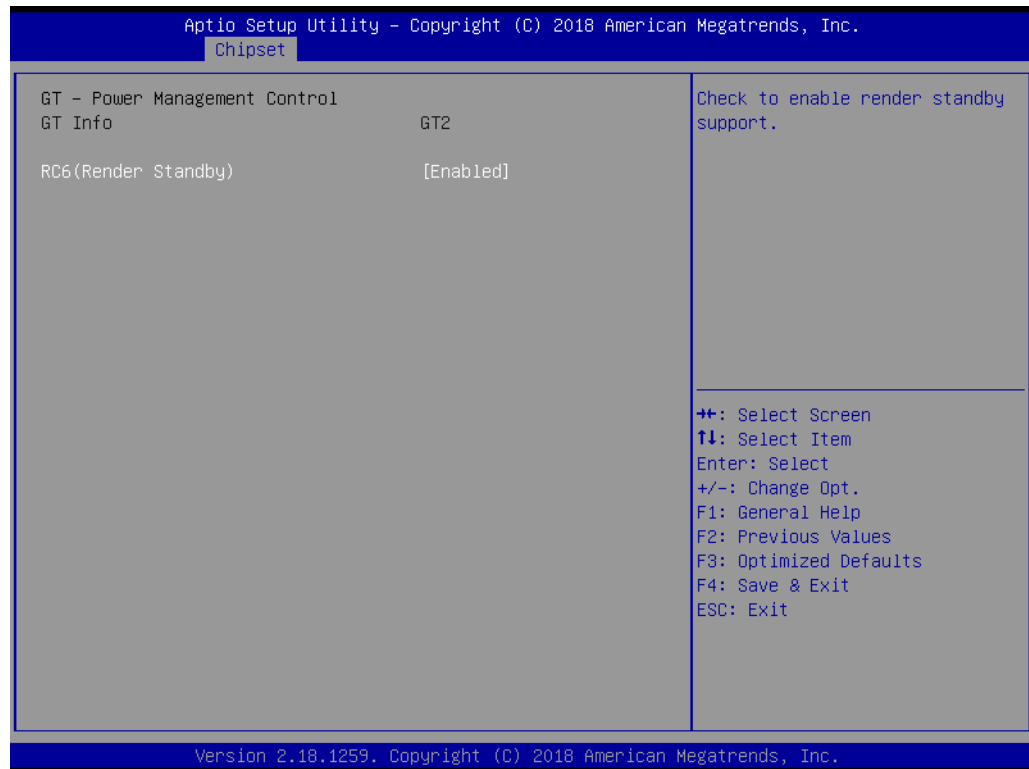

- RC6 (Render Standby)
This item checks to enable render standby support.

3.4.2 PCH-IO Configuration



- **Mini PCIE/mSATA Selection**
This item let users to select to enable Mini PCIE or mSATA for connector (CN15).
- **PCH LAN Controller**
This item allows users to enable/disable onboard NIC.
- **LAN Option ROM**
This item allows users to enable/disable LAN option ROM
- **Wake on LAN**
This item allows users to enable/disable integrated LAN to wake the system.
- **Onboard LAN2 Controller**
This item allows users to enable/disable onboard LAN2 Controller.
- **PCIE Wake**
This item allows users to enable/disable PCIE to wake the system from S5.
- **High Precision Timer**
This item allows users to enable/disable the High Precision Event Timer.
- **State After G3**
This item Specifies what state to go to when power is re-applied after a power failure (G3 state).

3.4.2.1 PCI Express Configuration

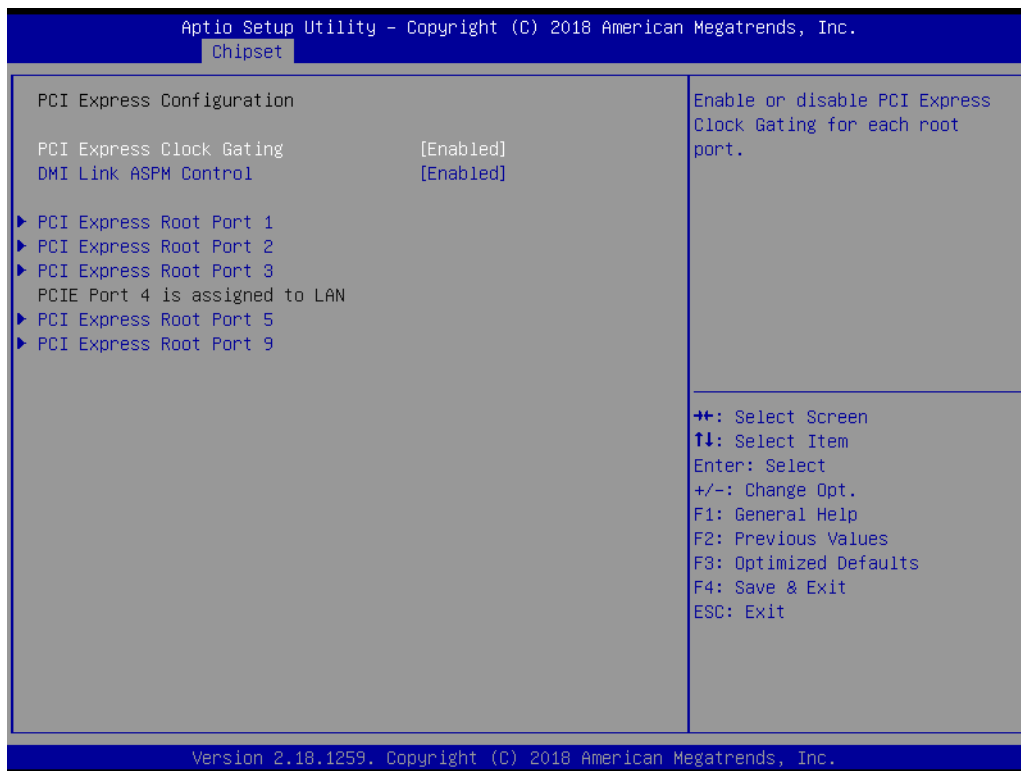

- **PCI Express Clock Gating**
This item allows users to enable/disable PCI Express Clock Gating
- **DMI Link ASPM Control**
This item allows users to enable/disable DMI Link ASPM Control
- **PCI Express Root Port 1**



– PCI Express Root Port\

- ASPM Support
- L1 Substates
- PCIe Speed
- Detect Non-Compliance Device

3.4.2.2 USB Configuration

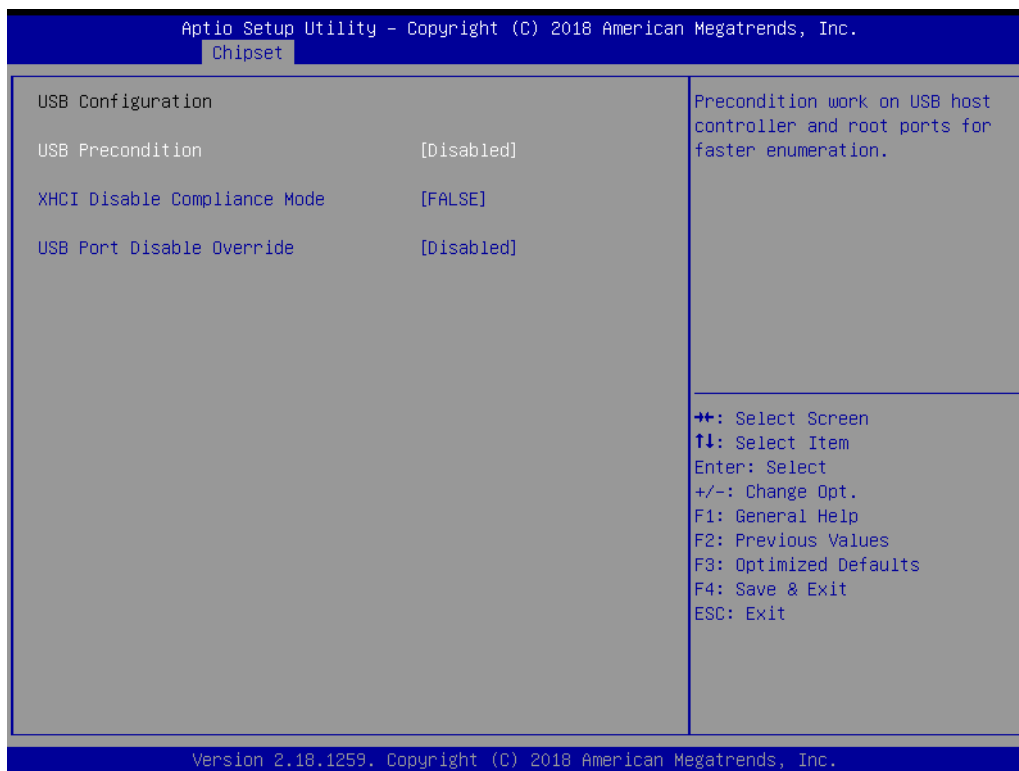

- **USB Precondition**
Precondition work on USB host controller and root ports for faster enumeration.
- **XHCI Disable Compliance Mode**
This item provides options to disable Compliance Mode. Default is FALSE to not disable Compliance Mode. Set TRUE to disable Compliance Mode.
- **USB Port Disable Override**
This item allows users to enable/disable the corresponding USB port from reporting a Device Connection to the controller.

3.4.2.3 BIOS Security Configuration

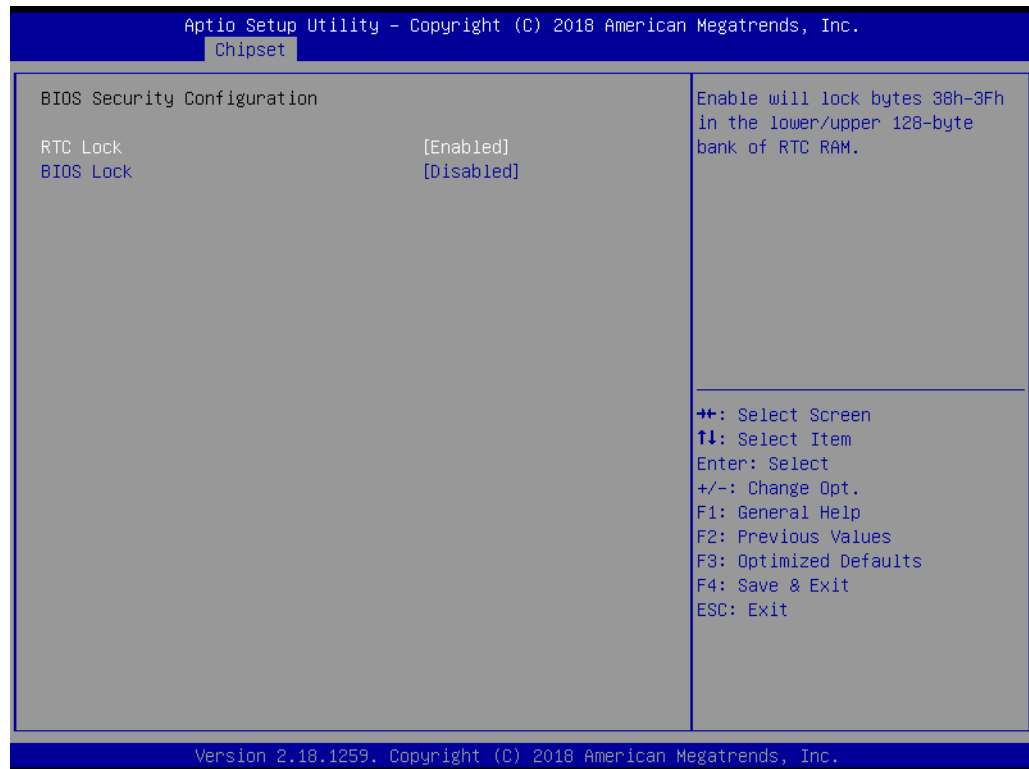

- **RTC Lock**
This item allows users to enable/disable RTC Lock.
- **BIOS Lock**
This item allows users to enable/disable the PCH BIOS Lock Enable (BLE bit) feature.

3.4.2.4 HD Audio Configuration

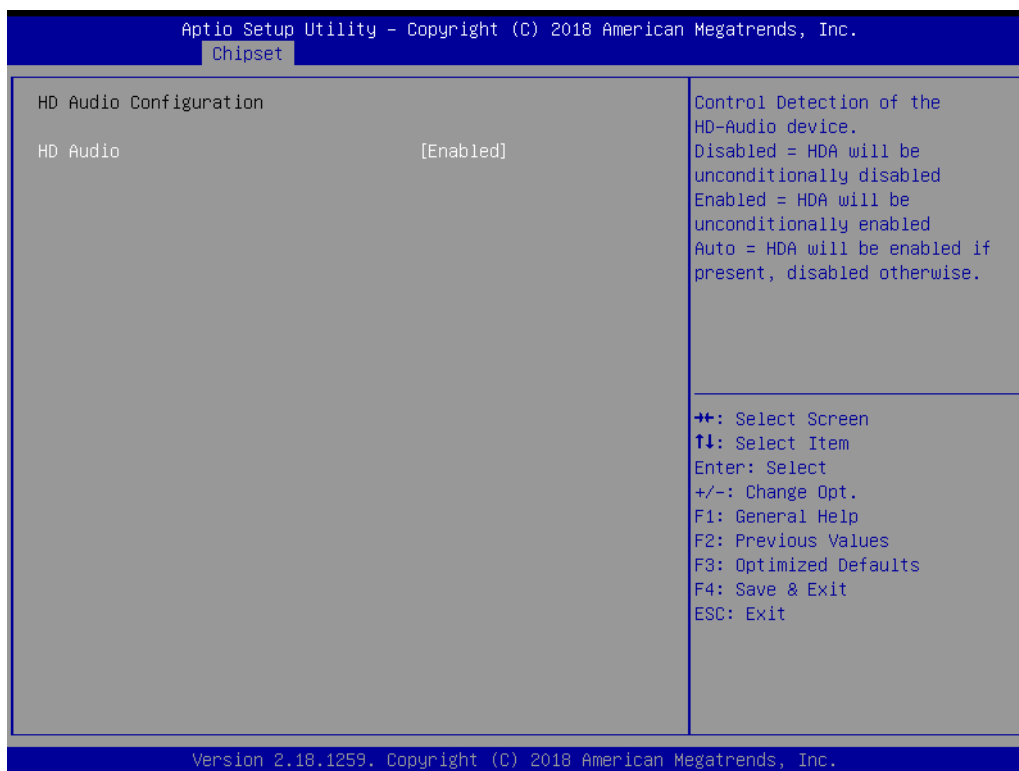

- **HD Audio**
This item allows users to enable/disable HD Audio

3.4.2.5 SB Porting Configuration



- **SATA RAID ROM**

This item allows users to switch between Legacy ROM/ UEFI Driver/ Both.
Legacy ROM: Legacy option ROM. UEFI Driver: UEFI Raid Driver. Both: Run the legacy Option ROM and UEFI driver.

3.5 Security Setup

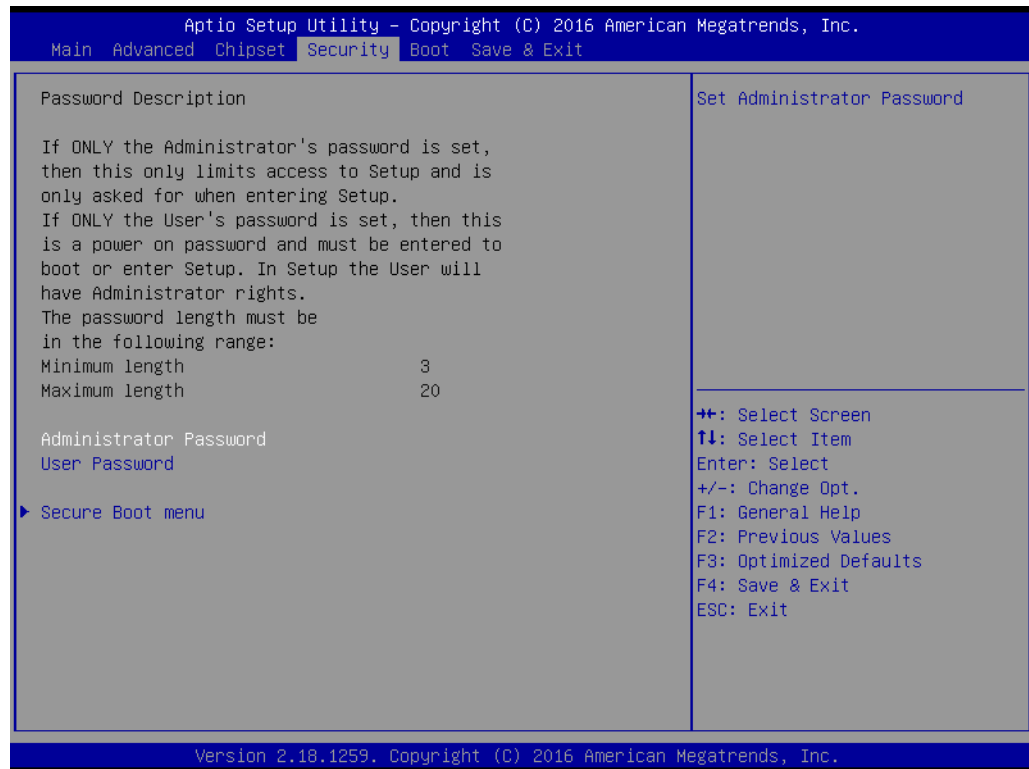

Select Security Setup from the ARK-2250 Setup main BIOS setup menu. All Security Setup options, such as password protection is described in this section. To access the sub menu for the following items, select the item and press <Enter>:

- **Change Administrator / User Password**

Select this option and press <ENTER> to access the sub menu, and then type in the password.

3.6 Boot Settings

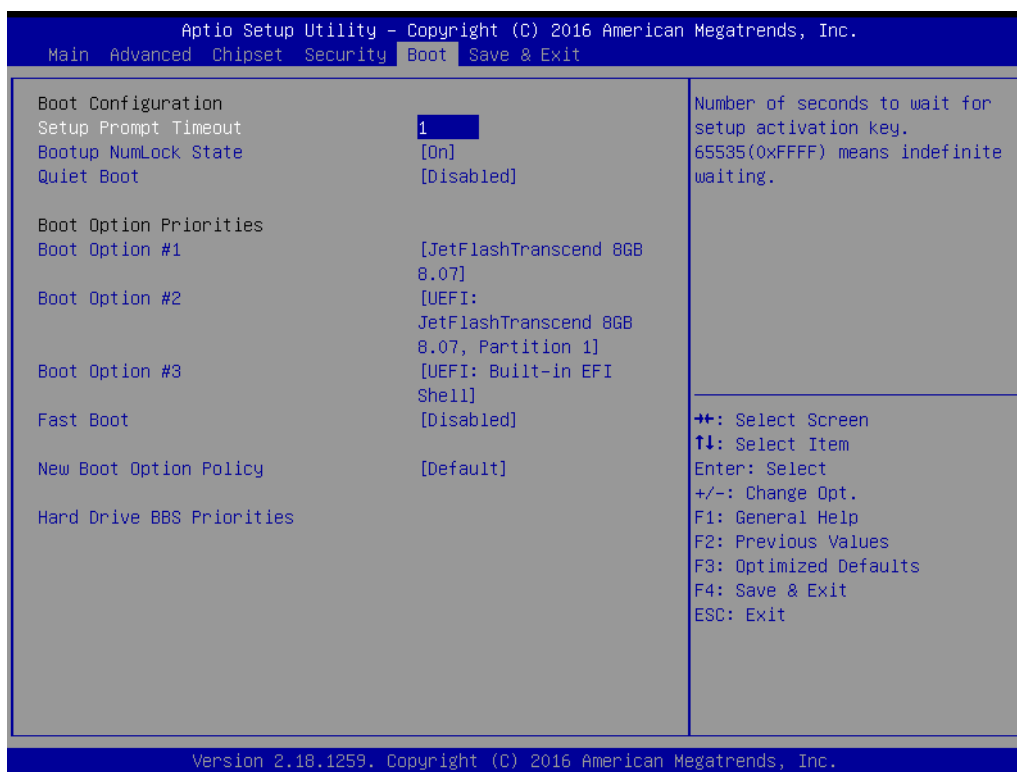

- **Setup Prompt Timeout**
Number of seconds that the firmware will wait before initiating the original default boot selection. A value of 0 indicates that the default boot selection is to be initiated immediately on boot. A value of 65535 (0xFFFF) indicates that firmware will wait for user input before booting. This means the default boot selection is not automatically started by the firmware.
- **Bootup NumLock State**
Select the keyboard NumLock state.
- **Quiet Boot**
Enables or disables Quiet Boot option.
- **Boot Option #1**
Sets the system boot order.

3.7 Save & Exit

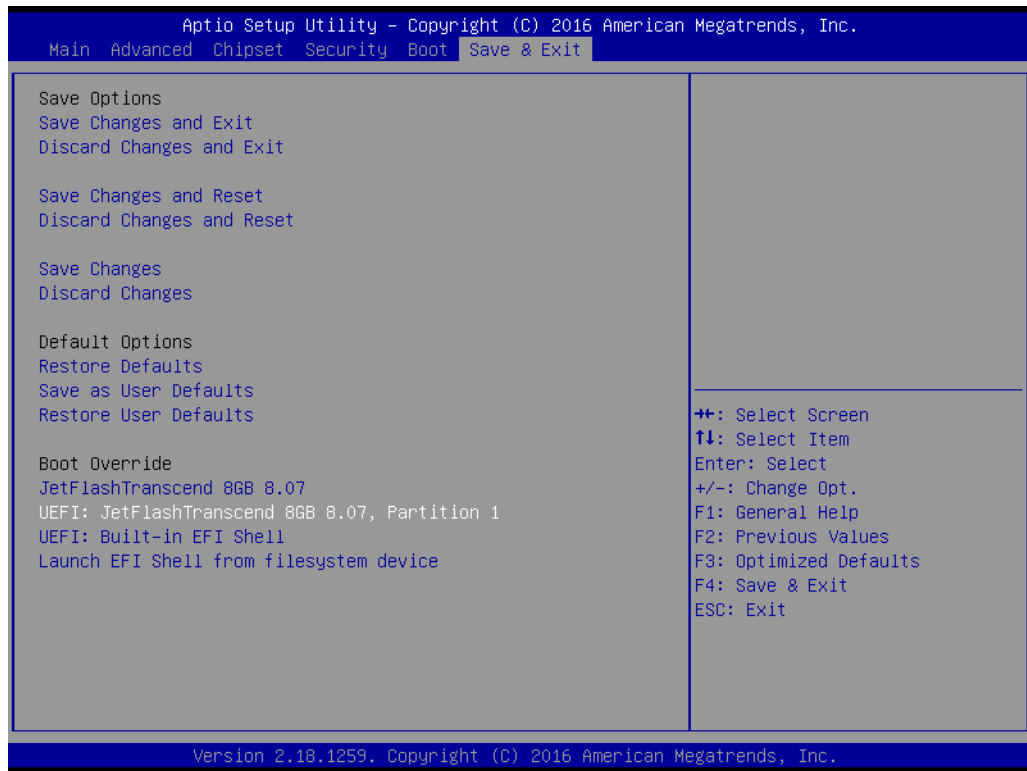

- **Save Changes and Exit**
This item allows you to exit system setup after saving the changes.
- **Discard Changes and Exit**
This item allows you to exit system setup without saving any changes.
- **Save Changes and Reset**
This item allows you to reset the system after saving the changes.
- **Discard Changes and Reset**
This item allows you to rest system setup without saving any changes.
- **Save Changes**
This item allows you to save changes done so far to any of the options.
- **Discard Changes**
This item allows you to discard changes done so far to any of the options.
- **Restore Defaults**
This item allows you to restore/load default values for all the options.
- **Save as User Defaults**
This item allows you to save the changes done so far as user defaults.
- **Restore User Defaults**
This item allows you to restore the user defaults to all the options.
- **Boot Override**
Boot device select can override your boot priority.

Appendix **A**

Watchdog Timer
Sample Code

A.1 EC Watchdog Timer sample code

```
EC_Command_Port = 0x29Ah
EC_Data_Port = 0x299h
Write EC HW ram = 0x89
Watch dog event flag = 0x57
Watchdog reset delay time = 0x5E
Reset event = 0x04
Start WDT function = 0x28
=====
.model small
.486p
.stack 256
.data
.code
org 100h
.STARTup

mov dx, EC_Command_Port
mov al,89h      ; Write EC HW ram.
out dx,al

mov dx, EC_Command_Port
mov al, 5Fh     ; Watchdog reset delay time low byte (5Eh is high byte) index.
out dx,al

mov dx, EC_Data_Port
mov al, 30h     ;Set 3 seconds delay time.
out dx,al

mov dx, EC_Command_Port
mov al,89h     ; Write EC HW ram.
out dx,al

mov dx, EC_Command_Port
mov al, 57h    ; Watch dog event flag.
out dx,al

mov dx, EC_Data_Port
mov al, 04h    ; Reset event.
out dx,al

mov dx, EC_Command_Port
mov al,28h    ; start WDT function.
out dx,al

.exit
END
```

ADVANTECH

Enabling an Intelligent Planet

www.advantech.com

Please verify specifications before quoting. This guide is intended for reference purposes only.

All product specifications are subject to change without notice.

No part of this publication may be reproduced in any form or by any means, electronic, photocopying, recording or otherwise, without prior written permission from the publisher.

All brand and product names are trademarks or registered trademarks of their respective companies.

© Advantech Co., Ltd. 2022